



## सोलापूर महानगरपालिका, सोलापूर

'इंद्रभुवन' आंबेडकर चौक, रेल्वे लाईन्स, सोलापूर ४१३ ००१.  
सार्वजनिक आरोग्य अभियंता (जलवितरण विभाग)

smcpnewtr@gmail.com



जा.क्र. साआअ/जल/ ९८७

दिनांक :- १२/०३/२०२५

### - Walk in Interview -

सोलापूर महानगरपालिकेच्या क्षेत्रात दैनंदिन व सुरळीत पाणीपुरवठा होणेच्या दृष्टीकोनातून अस्तित्वातील जलवितरण व्यवस्थेमध्ये सुधारणा करणेकामी या कामात तज्ञ व अनुभवी सल्लागार नेमणेचे आहे. त्याकरीता महानगरपालिकेतील मिटींग हॉल येथे दि. 25/ 03 /2025 रोजी सकाळी 11.00 वाजता अशा तांत्रिक तज्ञ व अनुभवी असलेले अभियंता / फ्री लान्सर सल्लागार / निवृत्त शासकीय अभियंता / स्टार्टअप/ कंपनी यांनी वरील नमूद कामाच्या अनुषंगाने आवश्यक त्या तांत्रिक व तद्अनुषंगिक अनुभव प्रमाणपत्रासह मुलाखतीसाठी उपस्थित राहावे.

या कामाची आवश्यक माहिती [www.solapurcorporation.gov.in](http://www.solapurcorporation.gov.in) या संकेतस्थळावर उपलब्ध आहे.

अशा उमेदवाराचे निवड करण्याचे सर्व हक्क महानगरपालिकेने राखून ठेवले असून कोणत्याही उमेदवारास अपात्र केलेबाबत पत्रव्यवहार अथवा स्पष्टीकरण देणे त येणार नाही याची नोंद घ्यावी.

डॉ. सचिन ओंबासे (भा.प्र.से.)  
आयुक्त,  
सोलापूर महानगरपालिका, सोलापूर.

सोलापूर महानगरपालिकेच्या क्षेत्रातील दैनंदिन पाणीपुरवठा करणेकरीता कामाची व्याप्ती खालीलप्रमाणे आहे.

**A) कामाची व्याप्ती -**

- 1) तज्ञ सल्लागार यांना सोलापूर महानगरपालिकेच्या जलवितरण विभागाकडून दैनंदिन जलवितरण व्यवस्थेची माहिती घेऊन त्यामध्ये नागरीकांना दररोज अथवा अंशतः पाणी पुरवठा कशा पध्दतीने करता येईल याबाबत Action Plan तयार करून देणे.
- 2) सदर Action Plan नुसार शहराच्या कमीतकमी दोन भागात अस्तित्वातील जलवितरण कार्यपध्दतीत प्रत्यक्ष सादरीकरण करून नागरीकांना दररोज अथवा एक किंवा दोन दिवसआड पाणी पुरवठा करण्याचे Demo देणे.
- 3) अस्तित्वातील जलवितरण व्यवस्थेमध्ये Service Level Improvement करण्याचा Action Plan तयार करून देणे. तसेच NRW कमी करणेसाठी आराखडा तयार करून देणे

**B) काम पूर्ण करणेची मुदत -**

- 1) महानगरपालिकेकडून वर्क ऑर्डर दिल्यापासून 15 दिवसात दोन ठिकाणी नागरीकांना दररोज अथवा एक किंवा दोन दिवसआड पाणीपुरवठा करणेकरीता Action Plan तयार करून त्याचे सादरीकरण करणे.
- 2) झालेल्या सादरीकरणानुसार सदर Action Plan ला अंतिम मंजूरी दिल्यानंतर पुढील 15 दिवसात प्रत्यक्षात जागेवर दोन भागात अंमलबाजावणी करणे आवश्यक राहिल.

**C) पात्रता निकष -**

- 1) तज्ञ उमेदवाराकडे पाणीपुरवठा / स्थापत्य अथवा अश्या प्रकारच्या क्षेत्रातील ब्याचलर डिग्री अथवा मास्टर डिग्री प्रमाणपत्र असणे आवश्यक आहे.
- 2) तज्ञ उमेदवाराकडे / कंपनी कडे यापूर्वी कोणत्याही शहरातील महानगरपालिका क्षेत्रात दैनंदिन पाणीपुरवठा करून दिल्याचे अनुभवाचा दाखला असणे आवश्यक आहे.
- 3) तज्ञ उमेदवाराने मुलाखतीच्या दिवशी उक्त नमूद कामाशी संबंधित कोणत्याही शहरातील एखादा Case Study सोबत आणणे, त्याचे सादरीकरण करणे व प्रश्नांचे / शंका निरसन करणे आवश्यक आहे.

**D) निवड प्रक्रिया -**

- 1) तज्ञ उमेदवाराचे शैक्षणिक व अनुभवाचे प्रमाणपत्र योग्य असल्याची खात्री झाल्यानंतर अशा उमेदवारास महानगरपालिकेने नियुक्त केलेल्या पॅनल समोर मुलाखत देणे व केलेल्या कामाचे अनुभवाचे सादरीकरण करणे याकरीता 15 मिनिट वेळ दिला जाईल.
- 2) तज्ञ उमेदवारास पॅनलने ठरलेले गुण निकषानुसार मार्किंग दिल्यानंतर जास्तीत जास्त 03 उमेदवारांना उतरत्या क्रमाने कामाचे वर्क ऑर्डर देण्यात येईल.

- 2) तज्ञ उमेदवारास पॅनलने ठरलेले गुण निकषानुसार मार्किंग दिल्यानंतर जास्तीत जास्त 03 उमेदवारांना उतरत्या क्रमाने कामाचे वर्क ऑर्डर देण्यात येईल.

**E) सल्लागार फी -**

- 1) तज्ञ उमेदवारास / कंपनीस/ फर्म कडील त्याच्या Performance Basis वर र.रु. 3 ते 5 लाख इतकी रक्कम फी म्हणून देण्यात येईल.  
(फी निश्चितीचे सर्व अधिकार आयुक्त, सोलापूर महानगरपालिका यांचे राहतील.)

**E) मार्किंग सिस्टीम -**

| अ.क्र. | तपशील  | Marks |
|--------|--|-------|
| 1      | वैयक्तिक उमेदवार अथवा कंपनी/ फर्म यांचेकडील कर्मचारी कडे जर<br>अ) Bachelor Engineering चे प्रमाणपत्र असल्यास | 3     |
|        | ब) Master Degree Engineering चे प्रमाणपत्र असल्यास   | 5     |
| 2      | अ) उमेदवार/ कंपनी / फर्म कडे अनुभवाचा दाखला 10 वर्षांचे असल्यास  | 10    |
|        | ब) 15 वर्षांचे असल्यास   | 15    |
|        | क) 20 वर्षांचे असल्यास   | 20    |
| 3      | यापूर्वी कोणत्याही शहरात महानगरपालिका क्षेत्रात अशा पध्दतीचे काम केलेल्या Case Study याचे सादरीकरण           | 25    |
|        | एकूण -   | 50    |

**F) शर्ती व अटी -**

- 1) सदर कामाची वर्क ऑर्डर ही एक महिन्याकरीता असून, त्यास पुढे मुदतवाढ देणेचे झालेस त्याचे सर्व अधिकार आयुक्त, सोलापूर महानगरपालिका यांचे राहतील.
- 2) सदर मुलाखतीस उमेदवार/ कंपनी इ. स्वखर्चाने येणे अपेक्षित असून त्याचा कोणताही खर्च महानगरपालिका देणार नाही.
- 3) तज्ञ उमेदवार यांनी आपला अर्ज व वरील नमूद पात्रता निकष दर्शिविणारे योग्य कागदपत्रे, आय कार्ड साईज फोटो, आधार कार्ड सह सुस्पष्ट स्कॅन करून smccommissioner@yahoo.com या ई-मेल id वर दि.२१/३/२५ अखेर संध्याकाळी ६ वाजेपर्यंत पाठवावीत.



डॉ. सचिन आंबासे (भा.प्र.से)  
आयुक्त,  
सोलापूर महानगरपालिका, सोलापूर.

Please contact for any related information

Mr.Tapan Danke - Dy.Engg, Water Supply- 9423992596



SOLAPUR CITY DEVELOPMENT  
CORPORATION LIMITED



Appointment of Consultant for  
Preparation of Hydraulic  
Modelling and Master Plan  
along with Water Audit for  
Solapur Water Supply System

# FINAL WATER AUDIT REPORT

*SUBMITTED BY*

WAPCOS Limited  
Flat No. 101, Preshak Presidency,  
Opposite Old Pandhe Office, Near Baldava Hospital,  
Vasant Vihar, Old Pune Naka, Solapur-413001

**SEPTEMBER 2022**

**Table of Contents**

|   |    |
|---|----|
| Table of Contents _____                                       | 1  |
| List of Figures _____   | 2  |
| List of Tables _____  | 3  |
| Abbreviations _____   | 4  |
| Executive Summary _____                                       | 6  |
| 1. INTRODUCTION _____   | 1  |
| 1.1 Project Background _____                                  | 1  |
| 1.2 Project Information _____                                 | 1  |
| 1.3 Report Information _____                                  | 1  |
| 1.4 References Collected for Water Audit Work _____           | 1  |
| 2. SCOPE AND METHODOLOGY _____                                | 2  |
| 2.1 Scope of Work _____                                       | 2  |
| 2.2 Standard Methodology _____                                | 2  |
| 2.3 Solapur Water Supply System _____                         | 5  |
| 2.3 Temporary Measurements _____                              | 11 |
| 2.4 Consumer Survey _____                                     | 12 |
| 3. WATER DATA AUDIT _____                                     | 13 |
| 3.1 Audit Components _____                                    | 13 |
| 4. IWA Water Balance _____                                    | 28 |
| 5. DEFICIENCIES & IMPROVEMENT SUGGESTIONS _____               | 30 |
| 5.1 List of Deficiencies _____                                | 30 |
| 5.2 Key Actions to be adopted _____                           | 35 |
| 6. REFERENCES _____   | 38 |
| ANNEXURE -1 A (Raw Water Transmission System Key Map) _____   | 1  |
| ANNEXURE -1 B (Clear Water Transmission System Key Map) _____ | 1  |

**List of Figures**

|   |    |
|---|----|
| figure 3:1 google Earth Image Of The All Drinking Water Sources In Solapur City ..... | 5  |
| Figure 3:2 Google Earth Image Of Bhavani Peth Wtp.....                                | 6  |
| Figure 3:3 Bhavani Peth Wtp Images.....   | 6  |
| Figure 3:4 Schematic Diagram Of Bhavani Peth Wtp .....                                | 6  |
| Figure 3:5 Google Earth Image Of Soregaon Wtp .....                                   | 7  |
| Figure 3:6images Of Soregaon Wtp .....  | 7  |
| Figure 3:7 Schematic Diagram Of Soregaon Wtp.....                                     | 8  |
| Figure 3:8google Earth Image Of Pakhni Wtp.....                                       | 8  |
| Figure 3:9images Of Pakhni Wtp .....  | 9  |
| Figure 3:10schematic Diagram Of Pakhni Wtp .....                                      | 9  |
| Figure 3:11solapur Zone Map .....   | 11 |
| Figure 9 Schematic Diagram - Bhavani Peth Wtp .....                                   | 14 |
| Figure 10 Schematic Diagram - Soregaon Wtp.....                                       | 16 |
| Figure 11schematic Diagram - Pakni Wtp .....  | 18 |



**List of Tables**

|  |    |
|--|----|
| Table 1 IWA Water Balance .....  | 6  |
| Table 2 IWA Water Balance Format.....  | 2  |
| Table 3 Consumer Survey Summary.....   | 12 |
| Table 4 Average Daily Flows - Bhavani Peth WTP.....                              | 13 |
| Table 5 Ekrukh Tank Volumetric Data .....  | 14 |
| Table 6 Bhavani Peth WTP Volumetric Details.....                                 | 15 |
| Table 7 Average Daily Flows - Soregaon WTP .....                                 | 15 |
| Table 8 Takli Source Volumetric Data.....  | 16 |
| Table 9 Soregaon WTP Volumetric Details .....                                    | 17 |
| Table 10 Average Daily Flows - Pakni WTP.....                                    | 18 |
| Table 11 Ujani Dam Source Volumetric Data.....                                   | 18 |
| Table 12 Pakni WTP Volumetric Details .....                                      | 19 |
| Table 13 Summary - WTP Production .....  | 20 |
| Table 14 Summary - Raw Water Inflow .....  | 20 |
| Table 15 MIDC Flow Comparison.....   | 21 |
| Table 16 Godutai Parulekar Taping Flow Comparison.....                           | 21 |
| Table 17 Summary - Billed Water Export.....                                      | 21 |
| Table 18 Summary - Water Supplied in SMC Area.....                               | 21 |
| Table 19 Previous Records of Metered Connections (Source: SMC).....              | 22 |
| Table 20 Details of Connections above 15mm (Source: SMC) .....                   | 22 |
| Table 21 Count of Billed Metered Consumers as per current SMC Billing Data ..... | 22 |
| Table 22 Summary - Billed Metered Consumption .....                              | 23 |
| Table 23 List of Authorized Unmetered Individual Connections .....               | 23 |
| Table 24 Summary - Meter Sampling for Individual Connections .....               | 23 |
| Table 25 Volumetric Estimates for Individual Connections .....                   | 23 |
| Table 26 PSP Sample Volume .....   | 24 |
| Table 27 Estimated Consumption from PSP.....                                     | 24 |
| Table 28 Billed Unmetered Volume.....  | 24 |
| Table 29 Slum Population .....   | 25 |
| Table 30 Slum Population and Unbilled Volume.....                                | 25 |
| Table 31 Public Utilites and Other Unbilled Volume .....                         | 25 |
| Table 32 Unbilled Unmetered Volume .....   | 26 |
| Table 33 Illegal Consumption Estimate .....                                      | 26 |
| Table 34 Slum Population and Unauthorized Volume.....                            | 26 |
| Table 35 Unaccounted Volume .....  | 26 |
| Table 36 Unauthorized Consumption.....   | 27 |
| Table 37 IWA Water Balance .....   | 28 |
| Table 5:1: Priority 1 - Measurement Locations.....                               | 30 |
| Table 5:2 Priority 2 - Measurement Locations.....                                | 30 |
| Table 5:3 List of Known Tapings.....   | 33 |
| Table 5:4: Summary - Consumer Survey .....                                       | 34 |

### Abbreviations

|        |  |
|--------|--|
| ABD    | Area Based Development   |
| AMRUT  | Atal Mission for Urban Rejuvenation and Urban Transformation   |
| BPT    | Brake Pressure Tank  |
| CI     | Cast Iron  |
| CPHEEO | Central Public Health & Environmental Engineering Organisation |
| DGPS   | Differential Global Positioning System                         |
| DPR    | Detailed Project Report  |
| DI     | Ductile Iron   |
| ESR    | Elevated Service Reservoir                                     |
| FSL    | Full Supply Level  |
| GCP    | Ground Control Points  |
| GI     | Galvanised Iron  |
| GIS    | Geographic Information System                                  |
| GSR    | Ground Service Reservoir                                       |
| HDPE   | High-density polyethylene                                      |
| HSR    | Hill Service Reservoir   |
| ISO    | Indian Standard Organisation                                   |
| IWA    | International Water Association                                |
| KL     | Kilo litre   |
| LPCD   | litre Per Capita Per Day                                       |
| MBR    | Main Balancing Reservoir                                       |
| MIDC   | Maharashtra Industrial Development Corporation                 |
| MJP    | Maharashtra Jeevan Pradhikaran                                 |
| MLD    | Million Litre per Day  |
| MoHUA  | Ministry of Housing and Urban Affairs                          |
| MoUD   | Ministry of Urban Development                                  |
| MS     | Mild Steel   |
| MSL    | Mean Sea Level   |
| MWL    | Mean Water Line  |
| NA     | Not Available  |
| NRW    | Non-Revenue Water  |
| PHE    | Public Health Engineering Department                           |
| PFR    | Pre-Feasibility Report   |
| PSC    | Pre-Stressed Concrete  |
| PTN    | Property Tax Number  |
| PVC    | Poly Vinyl Chloride Pipes                                      |
| RCC    | Reinforced Cement Concrete                                     |
| RFP    | Request for Proposal   |
| RL     | Reduced Level  |
| SCADA  | Supervisory Control and Data Acquisition                       |
| SCDCL  | Solapur City Development Corporation Limited                   |
| SMC    | Solapur Municipal Corporation                                  |



|              |   |
|--------------|---|
| STP          | Sewage treatment plant  |
| UFW          | Unaccounted for Flow  |
| UIDSMMT      | Urban Infrastructure Development Scheme for Small and Medium Towns Scheme |
| ULBs/UTILITY | Urban Local Bodies  |
| WSS          | Water Supply System   |
| WTP          | Water Treatment Plant   |

## EXECUTIVE SUMMARY

This Water Audit Report provides detail of data collected, references, measurements done, and calculation of various audit components and a Water Balance Table.

The water network in Solapur town is very complex with 3 WTPs and 52 Elevated Tanks/Reservoirs. Bhavani Peth, the oldest WTP is cross fed by the Pakni WTP Transmission line. Most of the ESRs (37 No.) are bypassed and directly feeding to the distribution network, exposing the transmission system to fluctuations due to network demand changes. There are roughly 116 thousand consumers in SMC records. There are roughly 127 thousand consumers paying general tax and do not get water directly from a house connection; there are 1803 Public Stand Posts in records. There are 2 external areas fed by the system known as MIDC Taping and Godutai Parulekar Taping. The volume supplied to these tapings are considered as billed water export. Based on field measurement and data provided by WAPCOS/SMC, the Water Balance table has been created as shown below:

TABLE 1 IWA WATER BALANCE

|  |   |  |   |   |   |
|--|---|--|---|---|---|
| <b>System<br/>Input<br/>Volume<br/>70,385 ML</b> | <b>Authorized<br/>Consumption<br/>29,559 ML<br/>42%</b> | <b>Billed<br/>Authorized<br/>27,910 ML<br/>40%</b> | <b>Billed Water Exported</b>                        | <b>Revenue<br/>Water<br/>27,910 ML<br/>40%</b>  |   |
|  |   |  | <b>3,792 ML<br/>5%</b>                              |   |   |
|  |   |  | <b>Billed Metered<br/>1,432 ML<br/>2%</b>           |   |   |
|  |   |  |   | <b>Billed Unmetered<br/>22,686 ML<br/>32%</b>   |   |
|  |   |  | <b>Unbilled<br/>Authorized<br/>1,649 ML<br/>2%</b>  | <b>Unbilled Metered<br/>N/A</b>   | <b>Non-<br/>Revenue<br/>Water<br/>42,475 ML<br/>60%</b> |
|  |   |  | <b>Unbilled Unmetered<br/>1,649 ML<br/>2%</b>       |   |   |
|  |   | <b>Apparent<br/>Losses<br/>11,231 ML<br/>16%</b>   | <b>Unauthorized<br/>11,231 ML<br/>16%</b>           |   |   |
|  |   | <b>Water Losses<br/>40,825 ML<br/>58%</b>          |   | <b>Cust. Meter Inaccuracy &amp; Data<br/>Handling Errors Negligible</b>   |   |
|  |   |  | <b>Real Losses<br/>(CARL)<br/>29,594 ML<br/>42%</b> | <b>Leakage in Transmission and<br/>Distribution Mains<br/>Storage Leaks and Overflows<br/>Service Con. Leaks up to Meters</b> |   |

It is important to note that Billed Metered Volume is very minimal. This is due to very limited metering in the city. Since meter installation is underway in ABD area, this situation will hopefully improve in the future, which is crucial for better water network management. Non-Revenue water is estimated to be 60% which is high. As of now water losses and wastage at consumer end cannot be segregated making it hard to act on Water Loss and this situation may deteriorate further if rehabilitation, metering, sectorization and network monitoring is not carried out immediately. During the preparation of this report, Network rehabilitation, DMA planning and metering (in ABD area) are underway in Solapur which should help in reduction of NRW. The implementation of SCADA will help in individual flow and pressure sensor data capture. Timely implementation of above capital works is the key to improve water supply situation of Solapur. It is also the right time to implement a comprehensive Network/DMA monitoring system, which is not planned for Solapur at this stage. The following key action points are suggested for continuous monitoring/improvement of water supply system and early warning for system failure/faster response planning.

### **Step 1: Capture Field Data**

Suggested Timeline: Immediate

Ensure Flow and Pressure data history is available for:

- (a) All WTP Outlet Pipelines.
- (b) All ESR Inlets before bypass pipeline.

Suggested Timeline: As per planned rehabilitation work

Ensure sensor and meter data is captured in the system after rehabilitation work.

- (c) Install Level Sensors at ESRs that are not bypassed. Subsequently in all ESRs after rehabilitation and closure of bypass.
- (d) Install Flowmeter and Pressure Loggers at DMA Inlet/Outlet points and Pressure Loggers at average and critical points.
- (e) Install consumer meters along with DMA implementation and capture Consumer ID, Coordinates and Meter initial data while installation.

It is suggested to log data every 5 minutes for remote locations and every minute for locations like OHT and PS. If the data is not available for various reasons like flowmeter/logger/transmitter not working, repair time should be tracked and targeted to be minimal.

### **Step 2: Analyze and Monitor**

Suggested Timeline: Initiate as soon as possible but after Step 1 (a) and (b) are complete.

Deploy DMA/Network Monitoring software for consolidation of various data including SCADA, Billing, and leakages etc and for the calculation of system inlet volume estimates along with Water Loss and KPI tracking. Initial observation can be limited to Transmission Network Monitoring and later DMAs can be included as and when established in the field. The software should provide the following outputs:

1. Data Analytics: Daily System Inlet Volume and Average Supply Pressures, Consumption Volumes
2. Water Network/KPI Monitoring: Hydraulic Model calibration and correlation with observed data on regular basis, Monthly Water Supply KPI tracking and Water Loss Estimates and timely identification of NRW related events.

The purpose of continuous monitoring is to keep a close eye on distribution performance and get relevant data for subsequent improvements.

### **Step 3: Yearly Water Loss Reduction Action Plan**

(Timeline: Initiate after Step 2.)

Industry best practice is to prepare a yearly Water Loss reduction plan and track the plan throughout the year. If the focus is shifted away from Water Network performance, and smaller issues are not diagnosed and addressed in a timely manner; the cumulative impact will be more demand imbalance, low pressure/no water issues, faster deterioration of the system and associated consumer issues.

Analysis and data from previous steps will provide crucial information for this step. Initially the plan may be focused on Transmission Systems and subsequently include DMAs as they are established. The action plan may be created for the calendar or financial year and must be targeted at prime issues with specific actions within the year. The subsequent year action plan should include success/failure/learning inputs from previous year's implementation. This will enable utility in definite success in Water Loss reduction over a period.

Water Loss Reduction Action Plan will have more relevance once regular Network Monitoring is in place. Key points to cover in action plan are mentioned below.

1. Continuous Analysis
  - a. Generate monthly Water Balance and Network Monitoring report and analytics.
  - b. Utilize these data for Loss Reduction Planning and Loss Reduction Area Prioritization.
2. Apparent Loss Reduction
  - a. Metering of remaining unbilled or unauthorized connections.
  - b. Regular reading of existing consumer meters and prompt action on meter related issues.
  - c. Law enforcement to handle illegal connection/water theft.
  - d. Regular meter testing and replacement plans to keep meter errors to a minimum.
3. Real Loss Reduction
  - a. Central database and system for all Leakage and Repair work for the city. Inclusion of this data in subsequent network monitoring and analytics.
  - b. Zone and ESR wise tasks to address all visible leakages and water wastage. Inclusion of this data in subsequent network monitoring and analytics.

- c. Leak Detection Survey as per prioritization derived by network monitoring system. Inclusion of this data in central leakage and repair database.
  - d. Initiate network asset management, pipe condition log along with leakage rate assessment during repair work and water loss calculations per event. Inclusion of this data in subsequent network monitoring and analytics.
4. Optional but useful actions to support Water Loss reduction efforts
- a. Publicly posting Water Loss figures and Water Loss Reduction activities improve accountability and customer confidence.
  - b. Assessing utility staff capacity and regular training improve execution efficiency.

### **About this Report**

The following sections are present in this report.

- Introduction
- Scope and Methodology
- Water Data Audit
- Deficiencies and Improvement Suggestions

The current project is part of the SMC water supply improvement project, awarded to WAPCOS. The Water Data Audit calculations are dependent on the accuracy and completeness of details provided by SMC staff and WAPCOS, field conditions pertaining to portable measurement by team of WAPCOS, operational data accuracy during the observation period, and consideration and assumption detailed in Draft Water Audit Report submitted

.

## 1. INTRODUCTION

### 1.1 PROJECT BACKGROUND

Basic information about Solapur City is included below. This data has been collected from open data available in Municipal Corporation and Govt. of India websites. Some of the information is also collected from popular web resources like Google Maps, Wikipedia and Internet Search Engines like Microsoft Bing, and Google Search.

- Census Population 2011: 9,51,558
- No. of Households 2011: 1,88,503
- Average Household Size: 5.05
- Approximate Altitude: 457 m above MSL.
- Average Annual Rainfall: Approx. 30 in.
- Temperature Range: 28-42 Deg. C in Summer, 13-27 Deg C in Winter

Solapur Municipality Corporation is responsible for water supply to the city.

### 1.2 PROJECT INFORMATION

This Water Data Audit is part of an ongoing project awarded to WAPCOS by Solapur Municipal Corporation (SMC). The Water Data Audit comprises the segregation of total System Input Volume into various components like Billed and Unbilled Authorized consumption and Various Losses. It estimates yearly NRW volume of the entire system.

### 1.3 REPORT INFORMATION

This report provides water audit calculation for Solapur Municipal Corporation. The report is prepared with data collected from field measurements by WAPCOS, site visits, discussion with SCDC and SMC staff, past DPRs, Audit reports and other references provided and listed in this report.

### 1.4 REFERENCES COLLECTED FOR WATER AUDIT WORK

- Past DPR - Augmentation and Improvements in Solapur water supply scheme by Primove
- Past Water Data Audit Report –Developing Strategy for Reduction of NRW – Aug 2015 by CDM Smith
- Utility and Operational Information provided by SMC and SCDC staff
- Open data available in Municipal Corporation and Govt. of India websites



## 2. SCOPE AND METHODOLOGY

### 2.1 SCOPE OF WORK

Scope includes assessment of IWA Water Balance for Solapur Municipal Corporation, based on information provided by SMC and WAPCOS and field data captured at Field by WPCOS team.

TABLE 2 IWA WATER BALANCE FORMAT

|                     |                        |  |                              |                                |                   |
|---------------------|------------------------|--|------------------------------|--------------------------------|-------------------|
| System Input Volume | Authorized Consumption | Billed Authorized Consumption                  | Billed Water Exported        | Revenue Water                  |                   |
|                     |                        |  | Billed Metered Consumption   |                                |                   |
|                     |                        |  | Billed Unmetered Consumption |                                |                   |
|                     | Water Losses           | Unbilled Authorized Consumption                |                              | Unbilled Metered Consumption   | Non-Revenue Water |
|                     |                        |  |                              | Unbilled Unmetered Consumption |                   |
|                     |                        | Apparent Losses                                | Unauthorized Consumption     |                                |                   |
|                     | Real Losses            | Cust. Meter Inaccuracy & Data Handling Errors  |                              |                                |                   |
|                     |                        | Leakage in Transmission and Distribution Mains |                              |                                |                   |
|                     |                        | Storage Leaks and Overflows                    |                              |                                |                   |
|                     |                        | Service Connection Leaks up to Meters          |                              |                                |                   |

### 2.2 STANDARD METHODOLOGY

The objective of the Water Data Audit is to assess water loss between supply and consumption at a Utility level using temporary measurement of system inflow and correlation with consumption data. Various components of the water balance are shown in Table 1 above.

The standard methodology used to develop this audit is a Top-Down approach of gathering information from existing records, data and other information available from the Utility. The Top-Down Water Audit provides insights into where to focus during rehabilitation and water supply improvement projects.

The entire process is divided in 2 steps:

1. Quantification of supply and consumption data by measurement or estimation along with assessment of other water loss components by discussion with utility staff.
2. Various calculations for deriving Water Balance and NRW % at the utility level.

Before starting the Audit, a water supply system boundary is identified, and information is collected for any water volume imported or exported. A time period for data collection is selected based on data availability and usually pre-decided by the Utility. In the best-case scenario, a utility may carry out a water audit every financial year. More frequent analysis may also be done if long term volumetric data is regularly captured. The unit of water audit for yearly estimated volume is pre-set (in current project it is ML/Year) and kept consistent for all components.

No water utility has perfect data, while requesting data, it is usual to ask for the latest available data and longer duration records for better validation. To complete the audit calculation, it may be required to apply assumptions and considerations. All assumptions and considerations used in the development of this audit are identified in the report.

The Water Audit starts with a quantification step where volumetric data is compiled from all of the Utility sources. If an existing flow meter is present, it is used to capture volumes, if not a temporary flow meter is installed to capture the required data. A minimum of 24 hours of continuous meter data should be obtained. Alternatively, if pump technical details are available then volume estimates can be derived from that detail and pump operation logbooks.

Sometimes pipes are old and buried deep making it impossible to take temporary measurements. If measurement of actual discharge is not possible, the utility may be requested to provide any previously available records or other possible considerations. However, if all system inlet pipes are not available for temporary measurement, the water audit quality will be very poor and may not be able to provide reliable inputs for future water loss monitoring and reduction plans.

Volumetric data is captured at all clear water inlets to the water supply system as well as any water import or export points. The System Input Volume is derived by this formula:

$$\text{System Input Volume} = \text{Total Production of Water} + \text{Water Imported} - \text{Water Exported}$$

Quantification of Billed Authorized Consumption is done by collecting billing records from the customer billing system. Based on the method of meter reading or billing methodology employed by the utility, is quantified or estimated and categorized under metered or unmetered volume. Sample meter installation is carried out to assess consumption where metered consumption is not available. Sometimes a quantum of water is exported outside the system but still billed by the Utility and can be categorized as Billed Water Exported.

$$\text{Billed Metered Consumption} = \text{Sum of Billed Consumer's Metered Volume}$$

$$\text{Billed Unmetered Volume} = \text{Average Sample Meter Consumption} \times \text{Average Billed Consumers}$$

$$\text{Billed Water Exported} = \text{Sum of Billed Consumer's Volume Exported Outside Utility Water System}$$

Billed Authorized Consumption formula:

$$\text{Billed Authorized Consumption} = \text{Billed Metered Consumption} + \text{Billed Unmetered Consumption} + \text{Billed Water Exported}$$

Quantification of Unbilled Authorized Consumption is done by assessing various consumption volumes that are not billed but used for designated purpose like Residential Buildings, Public Stand Posts, Public Buildings, Public Gardens, Water Fountains, Swimming Pools, Construction Sites, Fire Fighting, Street Cleaning, or Supply to Schools. Quantification is done based on a combination of existing measurement, assumption and consideration in discussion with Utility. If a particular category has a significant population (e.g. Public Stand Posts) sample meters are installed at selective locations and consumption volume is estimated based on average unit consumption measurement and total count of locations.

Unbilled Authorized Consumption:

Unbilled Authorized Consumption = Unbilled Metered Consumption + Unbilled Unmetered Consumption

Calculation of total water loss is possible after Authorized Consumption is assessed. It is done by using following formula:

Total Water Loss = System Input Volume – Authorized Consumption

Where, Authorized Consumption = Billed Authorized Consumption + Unbilled Authorized Consumption

Water Loss is further segregated between Apparent Loss and Real Loss.

Calculation of Apparent Loss Volume is done by assessing 3 components: Data Handling Errors, Customer Meter Inaccuracies and Unauthorized Consumption. If consumer and billing data is available for 3 years or more, it can be analyzed by data scientists to discover possible data errors. Customer meter inaccuracies are usually estimated by meter testing of a sample of existing installed meters. Unauthorized consumption is derived from utility consultation, site visits, known issue lists and appropriate assumptions.

Current Annual Real Loss (CARL) = Total Water Loss – Apparent Loss

NRW(%) = 100 x (System Input Volume – Billed Authorized Consumption)/System Input Volume

Unavoidable Annual Real Loss (UARL) in liters/day = (18 x Lm + 0.8 x Nc + 25 x Lp)xP

Where, Lm is mains length in km, Nc is number of service connections, Lp is the total length of underground pipe between the edge of a street and customer meters in km and P is average operating pressure in meters.

Lm is either acquired from the utility database or a GIS map provided by Utility. Nc is derived by billing records. Lp is derived by multiplying total customer count by average individual connection length between the edge of street and customer meters based on general house service connection installation practices information available from Utility. Average operating pressure is estimated by field visits and discussion with Utility staff.

Infrastructure Leakage Index (ILI) formula:

ILI = CARL / UARL

Water Loss Per Connection formula:

Water Loss Per Connection = Total Water Loss / Total Number of Consumer Connection.

All calculations are shared with Utility as draft to collect feedback and further insight and this report is prepared with Water Balance and NRW information.

### 2.3 SOLAPUR WATER SUPPLY SYSTEM

For the current project the IWA methodology was applied based on local condition and data collected during initial site visits. Details of site visits and pictures are shown in Annexure 2. Data collected during site visits formed the basis of the Inception Report and subsequent calculation of Water Balance.

- **WATER SOURCE AND TREATMENT PLANTS**

Solapur Municipality Corporation is supplying water to Solapur city from surface water after treatment at WTPs. There are 3 WTPs known as Bhavani Peth, Soregaon and Pakhni. WTP locations are shown in the figure below. Raw Water Source of these WTPs are Ekrukh tank, Bhima River and Ujani dam on Bhima River. There are no SMC operated Borewells and small borewells in SMC area are privately owned and not considered as SMC's drinking water source for supply system.



FIGURE 2:1GOOGLE EARTH IMAGE OF THE ALL DRINKING WATER SOURCES IN SOLAPUR CITY

- **WTP 01: BHAVANI PETH**

Bhavani Peth WTP is the oldest WTP in the City. It was constructed in the year 1932. Ekrukh Tank is the raw water source of the WTP. During site visit and discussion with SMC staff, it was observed that additional treated water is fed from Pakhni WTP Transmission Main to clearwater



sump of this WTP to fill supply gap during summertime as Ekrukh Tank source fails to supply required water during summer.

WTP Capacity: 27 MLD



FIGURE 2:2 GOOGLE EARTH IMAGE OF BHAVANI PETH WTP

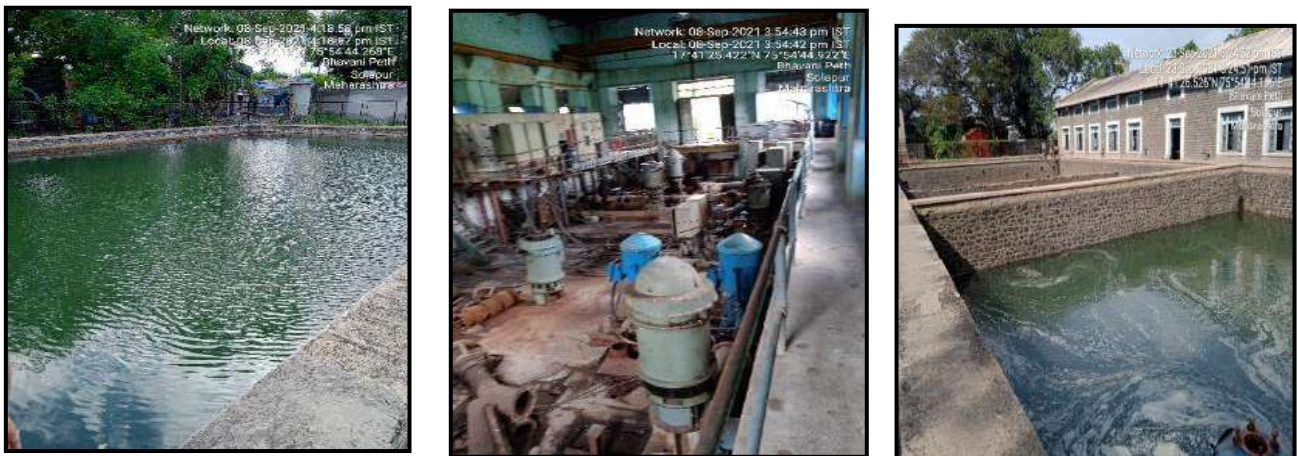

FIGURE 2:3 BHAVANI PETH WTP IMAGES

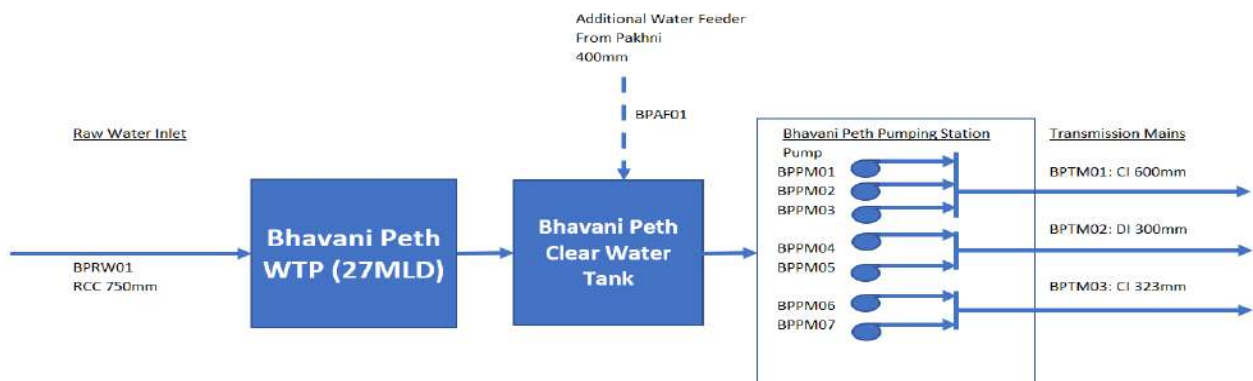

FIGURE 2:4 SCHEMATIC DIAGRAM OF BHAVANI PETH WTP



**Audit Steps taken:** Portable flow meters were installed to get daily inflow and outflow volumes at WTP 01, the logbook data was used to assess yearly water supply volumes.

- **WTP 02: SOREGAON**

Soregaon WTP is fed by Bhima River via head works at Takli which is 20 km away from WTP. It was augmented in 1984 when the capacity was increased from 54 to 108 MLD.

**WTP Capacity:** 108 MLD



**FIGURE 2:5 GOOGLE EARTH IMAGE OF SOREGAON WTP**



**FIGURE 2:6IMAGES OF SOREGAON WTP**



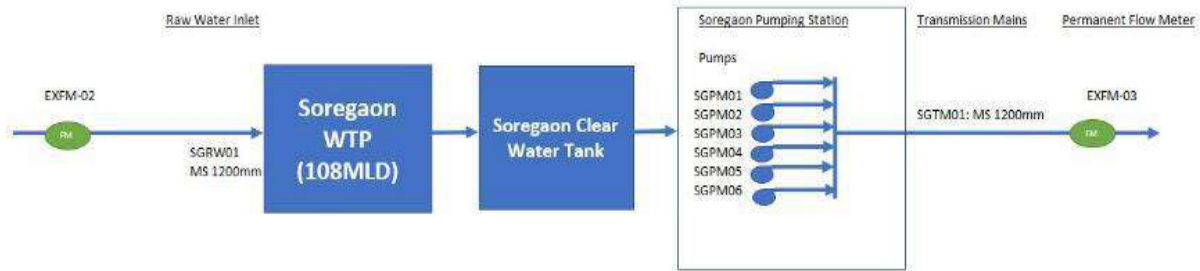

FIGURE 2:7 SCHEMATIC DIAGRAM OF SOREGAON WTP

**Audit Steps taken:** Portable flow meters were installed to get daily inflow and outflow volumes at WTP02, the logbook data was used to assess yearly water supply volumes.

- **WTP 03: PAKHNI**

Pakhni WTP was commissioned in 1998. It gets raw water from Ujani Dam which is located 110 km away from the city. Apart from providing water to the city, Pakhni WTP is also supplying water to Solapur MIDC area.

**WTP Capacity:** 80 MLD



FIGURE 2:8GOOGLE EARTH IMAGE OF PAKHNI WTP



FIGURE 2:9IMAGES OF PAKHNI WTP

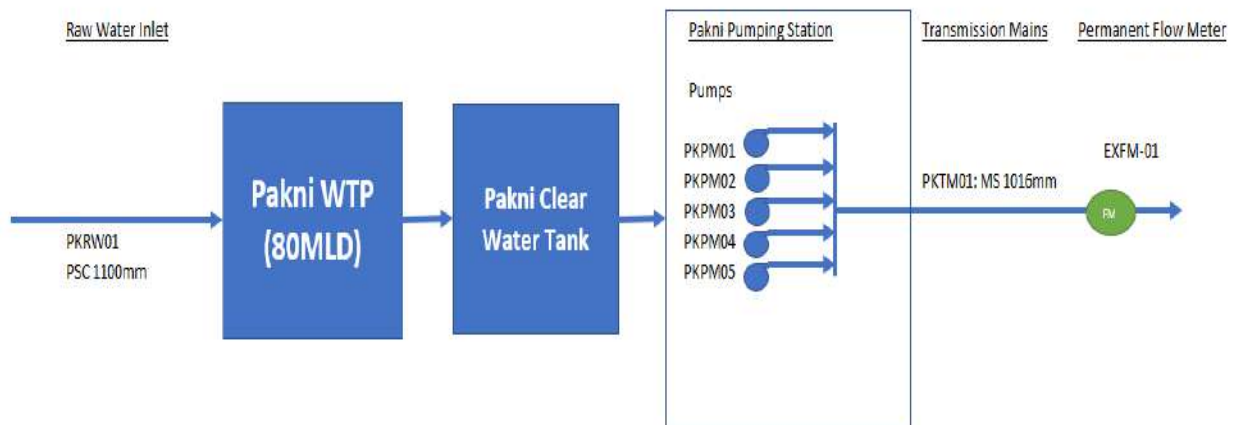

FIGURE 2:10SCHEMATIC DIAGRAM OF PAKHNI WTP

**Audit Steps taken:** Portable flow meters were installed to get daily inflow and outflow volumes at WTP 03, the logbook data was used to assess yearly water supply volumes.

- **TRANSMISSION SYSTEM**

There is a complex network of interconnected Transmission Mains in Solapur. The transmission network is supplying water to many distribution areas via direct tapings. It blurs the boundary between transmission and distribution. And most of the tanks are bypassed hence proper distribution volume and rationing of water supply cannot be assessed just by monitoring tanks. Hence the overall system cannot be divided into sections for monitoring flows. This is listed as deficiency in the subsequent section and a possible solution is mentioned as well. Fortunately, this does not affect the primary objective of the water audit as Water Balance is created by flow measurement at Inlet of WTPs and Water Export points. However, it should be addressed by SMC as early as possible for ongoing efficient operations.

Details of known taping points were collected for record purposes. The flow will fluctuate significantly and temporary measurement cannot provide insights on yearly volumes in such cases. This will not be a bottleneck for Water Audit but as soon as possible these tapings should be disconnected and the area should be merged with relevant ESR zone.

**Audit Step taken:** Transmission Network Length was calculated by latest available GIS Map. Water Balance was calculated from WTP Outlet flows and in addition water level data was captured where ESRs were not bypassed and various available water network information was used to estimate volumes.

Transmission System key map was created based on data collected from WAPCOS and SMC Staff and survey of Solapur Water Supply Facilities. Transmission Main Key Maps are shown in Annexure-1.

- **DISTRIBUTION SYSTEM**

Distribution network GIS map was received from WAPCOS and is used to calculate total network lengths. It is also used to locate sample meters and pressure survey locations.

**Audit Steps taken:** Distribution Network Length was calculated by latest available GIS Map. Areas for sample meter installation and pressure sample survey were identified using GIS Map in addition to discussion with WAPCOS and Utility engineers.

- **ZONES**

The Zone Map was used to distribute field observation points for consumer flow and pressure measurements.

Solapur Municipality Corporation Is Divided Into 8 Water Supply Zones as Shown in Figure Below:



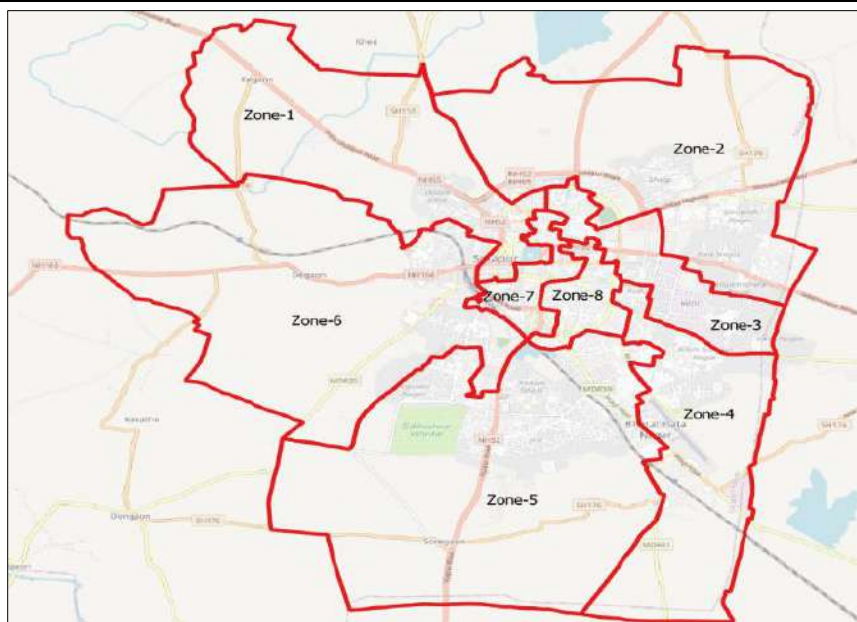

FIGURE 2:11 SOLAPUR ZONE MAP

- **CONSUMER AND BILLING DATA**

During preparation of the report, consumer survey was 76% complete (1,05,000 out of estimated 1,38,000 properties). For draft water audit calculation, total estimated property numbers were used which will get verified post survey and additionally slum population data received from SMC was also used for volume estimates. Billed consumer list was received from SMC and used to calculate authorized consumption. General Property Tax paying customer count was received from SMC and used for authorized consumption calculation.

**Audit Steps taken:** Billed data was used for billed consumption calculation. Since Consumer survey was not complete, total estimated property figures and other consideration were used for calculation of various consumption volume components. Specific interpretation of this data is discussed in subsequent section Water Data Audit Creation.

### 2.3 TEMPORARY MEASUREMENTS

For Water Data Audit, various temporary measurements were carried out.

**Audit Steps taken:** Temporary volumetric measurement wherever feasible.

Temporary measurements were carried out during different seasons to assess hourly flows. It is planned to execute one more set of readings during early summers and include it in final water audit. Request for necessary approval is submitted in this regard. Operational logs were used to estimate long term distribution volumes. In addition, existing working Flow Meter logs were collected wherever available. Raw Water withdrawal volumes were also collected to estimate losses in Raw Water Main. If logs were not found and average operational hours were not established than past reference data was considered along with WAPCOS/ SMC's inputs.

**Audit Steps taken:** Sample Consumer Meter Reading and Pressure Data was collected from consumers all over Solapur.

Residual pressure was collected for each subzone to calculate average system pressure. Sample consumer meters were installed at selected consumer locations in discussion with SMC. Secondary consumer locations were identified if the customer did not allow the installation.

## 2.4 CONSUMER SURVEY

Consumer Survey was done by the SMC in-house team. Total unique records for properties surveyed is listed in table below:

TABLE 3 CONSUMER SURVEY SUMMARY

| Area               | Stand Post   | Individual    | Grand Total   |
|--------------------|--------------|---------------|---------------|
| City               | 12613        | 72530         | 85143         |
| City Extension     | 18633        | 62184         | 80817         |
| Slum               | 12092        | 28105         | 40197         |
| <b>Grand Total</b> | <b>43338</b> | <b>162819</b> | <b>206157</b> |

All the data is GIS integrated and submitted as .shp files.

### 3. WATER DATA AUDIT

Final Water Audit Period is considered from Oct2021 to May 2022. Calculation for various components of IWA Water Balance are mentioned below.

#### 3.1 AUDIT COMPONENTS

##### SYSTEM INPUT VOLUME

There are 3 Water Treatment Plants and subsequent Clear Water Pumping Stations. System Input Volume is calculated by assessing total pumped volume along with accounting for flow transfers from Pakni to Bhavani Peth. There are no SMC operated borewells and there is no water imported from outside the system. There are 2 water export points MIDC Taping and Godutai Parulekar Taping. The exported water is billed exported volume hence it is considered part of the system and not subtracted from Input Volume. (It is categorized as Billed Volume Exported.)

- **Bhavani Peth WTP**

**WTP Outlet Volume:** Pumping flow rate was measured on site and average supply hours were calculated based on pump logbooks available at WTP site. Average daily flow in various months during the Audit Period is summarized in table below. Measurement sheets are enclosed in Annexure 3.

TABLE 4 AVERAGE DAILY FLOWS - BHAVANI PETH WTP

| Month          | Avg. Daily Flow (MLD) |
|----------------|-----------------------|
| Oct-21         | 37.58                 |
| Jan-22         | 36.13                 |
| Mar-22         | 38.13                 |
| May-22         | 36.55                 |
| <b>Average</b> | <b>37.10</b>          |

**Yearly pumped flow from Bhavani Peth Pumping Station is estimated to be 13,541 ML/Year. Average pumped flow per day is estimated to be 37.1 MLD. (WTP Production + Pakni Feeder)**

This pumped flow is the sum of WTP production and additional water received from Pakni as shown in the diagram below.



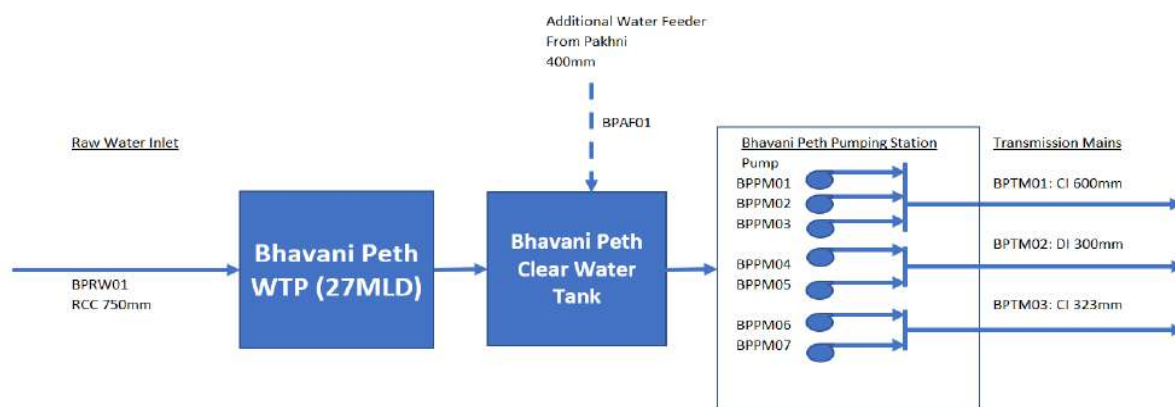

FIGURE 12 SCHEMATIC DIAGRAM - BHAVANI PETH WTP

In order to estimate flow from Pakhni Feeder, temporary measurement was carried out but flow readings showed significant fluctuations, most likely due to various valve operations and system demand changes. This is listed as deficiency in the subsequent section. It is clear that there are unscheduled valve operations upstream and downstream that are affecting the flow rate. In such cases, the only option available to the Utility is to install a permanent flowmeter.

There is no Flowmeter at Bhavani Peth WTP inlet and temporary measurement is also not possible here without risk of permanent damage to infrastructure, therefore in order to segregate the flow from the Pakhni feeder, volumetric data from the Raw Water Source (Ekrukh Tank) is used for calculation.

**Raw Water Source:** Ekrukh Tank outflows were captured from logbook data, audit period data from the log book is considered in Water Audit calculation.

TABLE 5 EKRUKH TANK VOLUMETRIC DATA

| Month                          | Volume (ML)     |
|--------------------------------|-----------------|
| Oct-21                         | 646.62          |
| Nov-21                         | 521.97          |
| Dec-21                         | 602.34          |
| Jan-22                         | 585.10          |
| Feb-22                         | 619.81          |
| Mar-22                         | 649.76          |
| Apr-22                         | 652.86          |
| May-22                         | 561.64          |
| <b>Total</b>                   | <b>4,840.09</b> |
| <b>Estimated Yearly Volume</b> | <b>7,260.13</b> |

**Yearly raw water inflow from the Ekrukh Tank is estimated to be 7,260 ML/Year. Average flow per day is estimated to be 19.89 MLD.**

As per the site visit and data captured from SMC staff, average WTP Losses at Bhavani Peth WTP are estimated to be 0.8 to 1 ML/Day. The 1 ML/Day value was used in the calculation. The values

cannot be validated as the inlet to the WTP is an old Concrete pipe buried deep and carries risk of permanent damage if excavated. It is suggested to consider modernization and permanent flow measurement at WTP inlet if SMC is willing to continue with this WTP operation in the future.

Measurement of losses on raw water line was not possible due to pipe material and accessibility issues. As the pipeline is very old PSC line, the loss volume cannot be nominal. Hence as per site visit, discussion with staff and based on available data, 5% value was used as an assumption. This value should be revised once permanent flow meters are installed at both ends of the Raw Water Pipeline.

TABLE 6 BHAVANI PETH WTP VOLUMETRIC DETAILS

| Details                         | ML/Year         | MLD          |
|---------------------------------|-----------------|--------------|
| Est. Yearly Raw Water Volume    | 7,260.13        | 19.89        |
| Transmission Losses             | 363.01          | 0.99         |
| WTP Losses                      | 365.00          | 1.00         |
| <b>Est. WTP Production</b>      | <b>6,532.12</b> | <b>17.90</b> |
| WTP+Pakni Feeder                | 13,541.10       | 37.10        |
| <b>Est. Pakni Feeder Inflow</b> | <b>7,008.98</b> | <b>19.20</b> |

**Yearly Bhavani Peth WTP Production is estimated to be 6,532 ML/Year. Average flow per day is estimated to be 17.90 MLD.**

**Inflow from Pakni to Bhavani Peth Sump is estimated to be 7,009 ML/Year. Average flow per day is estimated to be 19.20 MLD.**

### 1. Soregaon WTP

**WTP Outlet Volume:** Pumping flow rate was measured on site and average supply hours are calculated based on pump logbooks available at the WTP. Average daily flow in various months during the Audit Period is summarized in table below. Measurement sheets are enclosed in Annexure 3.

TABLE 7 AVERAGE DAILY FLOWS - SOREGAON WTP

| Month          | Avg. Daily Flow (MLD) |
|----------------|-----------------------|
| Oct-21         | 93.61                 |
| Dec-21         | 90.88                 |
| Mar-22         | 93.69                 |
| May-22         | 107.87                |
| <b>Average</b> | <b>96.51</b>          |

Schematic diagram of Soregaon WTP is shown in the figure below.



FIGURE 13 SCHEMATIC DIAGRAM - SOREGAON WTP

Field measurements were carried out on Clear Water Main at Soregaon WTP. Average flow rate observed: 4107 m<sup>3</sup>/hr.

The details of measurements are shared in Annexure 3. As pumping operation and hours vary, this flow rates also varies. Hence it cannot be used to determine long term supply volume and is not an alternative to permanent measurement. The flow rate is higher than average daily supply. Variation can be attributed to flow fluctuation, temporary shutdowns, equipment, human and data error. In this situation it is best to use pump log data and measured pump flow volume.

Soregaon WTP Outlet Main Line is equipped with a Flowmeter, but it is not working and the logbook data is available only for a few days in Aug-21. Flowmeter data was available from mid May-22 but readings were inconsistent. Since the data is available for very a limited period and mostly out of study period, not much insights were available for Audit calculations hence pumped flow and logbook data is used for estimating yearly volumes.

**Yearly Soregaon WTP Outflow volume is estimated to be 35,227 ML/Year. Average flow per day is estimated to be 96.51 MLD.**

**Raw Water Source:** Takli source outlet flowmeter data was captured from the logbook. Current financial year logbook data was used in the Draft Water Audit calculation.

TABLE 8 TAKLI SOURCE VOLUMETRIC DATA

| Month                          | Volume (ML)      |
|--------------------------------|------------------|
| Oct-21                         | 2,304.56         |
| Nov-21                         | 2,850.82         |
| Dec-21                         | 2,954.71         |
| Jan-22                         | 3,158.27         |
| Feb-22                         | 3,013.60         |
| Mar-22                         | 3,176.37         |
| Apr-22                         | 3,308.39         |
| May-22                         | 2,940.25         |
| <b>Total</b>                   | <b>23,706.96</b> |
| <b>Estimated Yearly Volume</b> | <b>35,560.44</b> |

Field measurements were carried out on the Raw Water Main near source at Takli. Average Flow Rate observed: 4634 m<sup>3</sup>/hr.

The detailed measurements are shared in Annexure 3. As pumping operation and hours vary, this flow rate also varies. Hence it cannot be used to determine long term supply volume and is not an alternative to permanent measurement. The flow rate is higher than average daily supply. Variation can be attributed to flow fluctuation, temporary shutdowns, equipment, human and data error. In this situation it is best to use volume supplied per month.

**Yearly raw water inflow from Takli Raw Water Source is estimated to be 35,560 ML/Year. Average flow per day is estimated to be 97.43 MLD.**

**Raw Water Inlet to Soregaon WTP:** The flowmeter at WTP inlet has not been working since 30-Sept-2021. Only data from September was available. Volume supplied during September is calculated to be 2677.86 ML. Usual flowrate was observed for 28 days with cumulative flow of 2627.76 ML, resulting in 93.85MLD flowrate on average. Since the data is for a limited period, it was not considered for segregation of transmission and WTP losses.

Field measurements were carried out on the Raw Water Main near Soregaon WTP. Average flow rate observed: 4225 m<sup>3</sup>/hr.

The detailed measurements are shared in Annexure 3. As pumping operation and hours vary, this flow rates also varies. Hence it cannot be used to determine long term supply volume and is not an alternative to permanent measurement. The flow rate is higher than average daily supply. Variation can be attributed to flow fluctuation, temporary shutdowns, equipment, human and data error.

Based on site visits and discussion with WAPCOS/SMC staff, it is understood that WTP losses are very minimal. For segregation of losses 0.5 ML/Day was used and transmission losses were derived as described below. This value should be revised once the permanent flow meter is repaired at the raw water inlet of Soregaon WTP.

TABLE 9 SOREGAON WTP VOLUMETRIC DETAILS

| Details                      | ML/Year   | MLD   |
|------------------------------|-----------|-------|
| Est. Yearly Raw Water Volume | 35,560.44 | 97.43 |
| Est. WTP Production          | 35,226.86 | 96.51 |
| WTP Losses                   | 182.50    | 0.50  |
| Transmission Losses          | 151.10    | 0.41  |

**The transmission losses come out to be 0.41 MLD, which is quite reasonable, considering short length of raw water main.**

## 2. Pakni WTP

**WTP Outlet Volume:** Pumping flow rate was measured on site and average supply hours were calculated based on pump logbooks available at the WTP site. Average daily flow in various months during the Audit Period is summarized in table below. Measurement sheets are enclosed in Annexure 3.

TABLE 10 AVERAGE DAILY FLOWS - PAKNI WTP

| Month          | Avg. Daily Flow (MLD) |
|----------------|-----------------------|
| Oct-21         | 78.08                 |
| Dec-21         | 80.92                 |
| Mar-22         | 77.14                 |
| May-22         | 77.57                 |
| <b>Average</b> | <b>78.43</b>          |

The schematic diagram of Soregaon WTP is shown in the figure below.

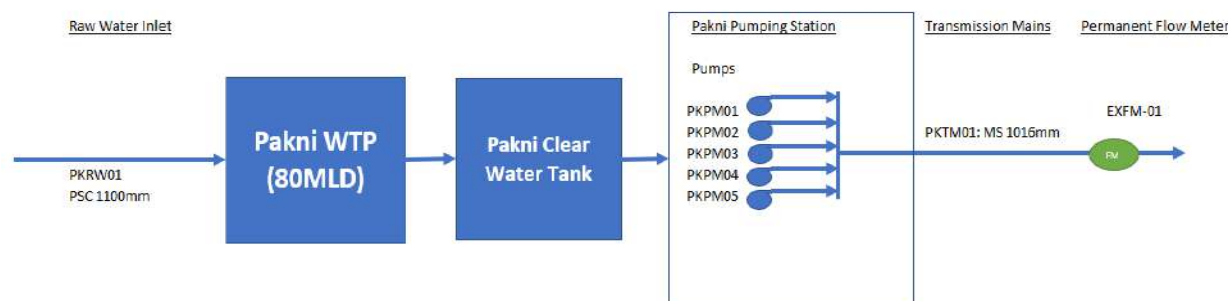

FIGURE 14 SCHEMATIC DIAGRAM - PAKNI WTP

Field measurements were carried out on Clear Water Main at Pakni WTP. Observed flow rate: 3338 m<sup>3</sup>/hr.

The detailed measurements are shared in Annexure 3. As pumping operation and hours vary, this flow rates also vary. Hence it cannot be used to determine long term supply volume and is not an alternative to permanent measurement. The flow rate is only slightly higher than average daily supply. Variation can be attributed to flow fluctuation, temporary shutdowns, equipment, human and data error. In this situation it is best to use pump log data and measured pump flow volume.

The Pakni WTP Outlet Main Line is equipped with a Flowmeter, but it is not working and logbook data is available only through April 2021. Since the data is available for a very limited period, which is also out of study period, it is not considered for the current Audit. It is recommended to repair this flowmeter as soon as possible.

**Yearly Pakni WTP Outflow volume is estimated to be 28,625 ML/Year. Average flow per day is estimated to be 78.43 MLD.**

**Raw Water Source:** Ujani Dam raw water source outlet flowmeter data was captured from the logbook. Current financial year logbook data was used in Draft Water Audit calculation below:

TABLE 11 UJANI DAM SOURCE VOLUMETRIC DATA

| Month | Volume (ML) |
|-------|-------------|
|-------|-------------|



|                                |                  |
|--------------------------------|------------------|
| Oct-21                         | 2,478.20         |
| Nov-21                         | 2,485.02         |
| Dec-21                         | 2,965.90         |
| Jan-22                         | 2,585.20         |
| Feb-22                         | 2,465.67         |
| Mar-22                         | 2,630.88         |
| Apr-22                         | 2,474.74         |
| May-22                         | 2,619.25         |
| <b>Total</b>                   | <b>20,704.85</b> |
| <b>Estimated Yearly Volume</b> | <b>31,057.27</b> |

Field measurements were carried out on the Raw Water Main near source at Ujani Dam. Observed flow rate: 3896 m<sup>3</sup>/hr.

The detailed measurements are shared in Annexure 3. As pumping operation and hours vary, this flow rates also varies. Hence it cannot be used to determine long term supply volume and is not an alternative to permanent measurement. The flow rate is higher than average daily supply. Variation can be attributed to flow fluctuation, temporary shutdowns, equipment, human and data error. In this situation it is best to use volume supplied per month.

**Yearly raw water inflow from Ujani Dam Raw Water Source is estimated to be 31,057 ML/Year. Average flow per day is estimated to be 85.09 MLD.**

**Raw Water Inlet to Pakni WTP:** There is no flowmeter at the inlet of Pakni WTP so losses within WTP are hard to assess. It is not possible to measure inflow pertaining to site conditions without exposing the pipe to damage risks, therefore temporary measurements were carried out near the raw water source location (Ujani Dam) and near BPT along the way.

Field measurements were carried out on the Raw Water Main near BPT. Observed flow rate: 3767 m<sup>3</sup>/hr.

The detailed measurements are shared in Annexure 3. As pumping operation and hours vary, this flow rate also varies. Hence it cannot be used to determine long term supply volume and is not an alternative to permanent measurement. The flow rate is higher than average daily supply. Variation can be attributed to flow fluctuation, temporary shutdowns, equipment, human and data error.

In the Pakni WTP, there is a filter backwash ESR of capacity 1 ML which is filled daily and there is a recirculation well recycling water from the filter backwash so there are no significant losses from this WTP. For the segregation of losses, 1 ML/Day was used for WTP losses, and transmission losses are derived as mentioned below. This value should be revised once a permanent flow meter is installed at raw water inlet of Pakni WTP.

TABLE 12 PAKNI WTP VOLUMETRIC DETAILS

| Details                      | ML/Year   | MLD   |
|------------------------------|-----------|-------|
| Est. Yearly Raw Water Volume | 31,057.27 | 85.09 |
| Est. WTP Production          | 28,625.81 | 78.43 |
| WTP Losses                   | 365.00    | 1.00  |
| Transmission Losses          | 2,066.5   | 5.66  |

The transmission losses come out to be 5.66 MLD, which is higher at 6.7%. Adjusting for minimal error of 1% at Raw Water source results in Raw Water Inflow 30,747 ML/Year and Transmission Losses in the range of 4.8 MLD (5.7%) which is still very high. It is also possible that higher value is resulted due to equipment or logbook error.

Permanent measurement is recommended at inlet of WTP to monitor these figures on regular basis.

Most of the losses can be attributed to 110km long transmission line half of which is PSC. Though no such visible leaks were noticed during site visit and measurement work. It is not unusual to extract water for irrigation, cattle feed, non-domestic purposes from Raw Water Mains. It is recommended to install Raw Water Inlet Flow Meter to track this Water Loss issue and if losses are consistent, rehabilitation or enforcement may be considered as necessary.

**Summary:** Following tables summarize the estimated yearly raw water and production volumes. The values will be revised as further data is captured and included in analysis.

TABLE 13 SUMMARY - WTP PRODUCTION

| Location                               | Estimated Yearly Volume (ML/Year) | Average Per Day (MLD) |
|--|-----------------------------------|-----------------------|
| Bhavani Peth WTP Outlet + Pakni Feeder | 13,541.10                         | 37.10                 |
| <b>Bhavani Peth WTP Production</b>     | <b>6,532.12</b>                   | <b>17.90</b>          |
| Pakni Feeder Volume Estimate           | 7,008.98                          | 19.20                 |
| <b>Soregaon WTP Production</b>         | <b>35,226.86</b>                  | <b>96.51</b>          |
| <b>Pakni WTP Production</b>            | <b>28,625.81</b>                  | <b>78.43</b>          |
| <b>Total WTP Production Estimate</b>   | <b>70,384.79</b>                  | <b>192.84</b>         |

TABLE 14 SUMMARY - RAW WATER INFLOW

| Location                               | Estimated Yearly Volume (ML/Year) | Average Per Day (MLD) |
|--|-----------------------------------|-----------------------|
| Raw Water Source (Ekrukh Tank)         | 7,260.13                          | 19.89                 |
| Raw Water Source (Takli)               | 35,560.44                         | 97.43                 |
| Raw Water Source (Ujani Dam)           | 31,057.27                         | 85.09                 |
| <b>Total Raw Water Inflow Estimate</b> | <b>73,877.84</b>                  | <b>202.41</b>         |

#### BILLED WATER EXPORTED

There are 2 tapings considered in the Billed Volume Export category.

- Chincholi MIDC Taping

- Godutai Parulekar Taping

Temporary flow measurement was carried out at Pakni Transmission Main taping for MIDC. Details are mentioned below.

TABLE 15 MIDC FLOW COMPARISON

| Ex Flow Meter (m3/hr) | Temp Flow Meter (m3/hr) | Difference(m3/hr) | Percent |
|-----------------------|-------------------------|-------------------|---------|
| 413.00                | 541.74                  | 128.74            | 24%     |

It is unusual to have such a difference, and reasons could be leakages or unauthorized consumption between these two-meter locations. As the pipe is above ground, it is visibly leaking and taped at multiple locations. The same is included in Site Visit Report.

Temporary flow measurement was also carried out at Godutai Parulekar Taping.

TABLE 16 GODUTAI PARULEKAR TAPING FLOW COMPARISON

| Details                  | Measured Flow (m3/hr) | Avg. Flow (MLD) |
|--------------------------|-----------------------|-----------------|
| Godutai Parulekar Taping | 150.87                | 3.62            |

The difference is 6.7% and variation can be attributed to flow fluctuation, temporary shutdowns, equipment, human and data error. Total Billed Water Export is summarized in table below.

TABLE 17 SUMMARY - BILLED WATER EXPORT

| Details                  | Est. Yearly Volume (ML/Year) | Considered Avg. Flow (MLD) |
|--------------------------|------------------------------|----------------------------|
| MIDC Taping              | 2,593.63                     | 7.11                       |
| Godutai Parulekar Taping | 1,198.68                     | 3.28                       |
| <b>Total</b>             | <b>3,792.32</b>              | <b>10.39</b>               |

#### WATER SUPPLIED TO SMC AREA

Water Supplied to SMC area was calculated and is in the table below.

TABLE 18 SUMMARY - WATER SUPPLIED IN SMC AREA

| Parameter                         | Est. Yearly Volume (ML/Year) | Avg. Daily Volume (MLD) |
|-----------------------------------|------------------------------|-------------------------|
| System Input Volume               | 70,384.79                    | 192.84                  |
| Billed Water Exported             | 3,792.32                     | 10.39                   |
| <b>Water Supplied to SMC Area</b> | <b>66,592.47</b>             | <b>182.45</b>           |

**The total water supplied to the SMC area is estimated to be 66,592 ML/Year. Average flow per day is estimated to be 182.45 MLD.**

**Billed Metered:** For authorized billed consumption calculation, consumer and billing data was collected and analyzed. Total metered consumer list as per previous records:

TABLE 19 PREVIOUS RECORDS OF METERED CONNECTIONS (SOURCE: SMC)

| S. No. | Conn. Dia. mm                 | Count | Total       |
|--------|-------------------------------|-------|-------------|
| 1      | 15mm in City Area             | 2224  | 5527        |
| 2      | 15mm in Extended Area         | 3303  |             |
| 3      | Above 15mm Private Connection | 171   | 310         |
| 4      | Above 15mm Govt. Connection   | 139   |             |
|        | <b>Total</b>                  |       | <b>5837</b> |

It is understood that meter-reading based billing is not done for 15mm connections. All 15mm connections are average billed along with rest of general property tax payers and meter reading is limited to only a few meters above 15mm.

TABLE 20 DETAILS OF CONNECTIONS ABOVE 15MM (SOURCE: SMC)

| S. No. | Size         | PRIVATE     |                 | GOVERNMENT  |                 | TOTAL COUNT |
|--------|--------------|-------------|-----------------|-------------|-----------------|-------------|
|        |              | RESIDENTIAL | NON-RESIDENTIAL | RESIDENTIAL | NON-RESIDENTIAL |             |
| 1      | 20mm         | 13          | 9               | 0           | 2               | 24          |
| 2      | 25mm         | 35          | 53              | 16          | 26              | 130         |
| 3      | 40mm         | 11          | 13              | 5           | 11              | 40          |
| 4      | 50mm         | 9           | 17              | 19          | 15              | 60          |
| 5      | 80mm         | 0           | 6               | 14          | 6               | 26          |
| 6      | 100mm        | 2           | 1               | 12          | 6               | 21          |
| 7      | 150mm        | 1           | 0               | 4           | 2               | 7           |
| 8      | 300mm        | 0           | 0               | 0           | 1               | 1           |
| 9      | 400mm        | 1           | 0               | 0           | 0               | 1           |
|        | <b>Total</b> | <b>72</b>   | <b>99</b>       | <b>70</b>   | <b>69</b>       | <b>310</b>  |

However, this list was superseded by current data received from the billing department, which had 175 billing records in March-2022. The list is enclosed in Annexure 3.

TABLE 21 COUNT OF BILLED METERED CONSUMERS AS PER CURRENT SMC BILLING DATA

| Connection Size | Count |
|-----------------|-------|
| 20mm            | 7     |
| 25mm            | 55    |
| 40mm            | 24    |
| 50mm            | 40    |
| 80mm            | 20    |
| 100mm           | 15    |
| 150mm           | 10    |
| 300mm           | 1     |

| Connection Size | Count      |
|-----------------|------------|
| Other           | 3          |
| <b>Total</b>    | <b>175</b> |

Billing history collected for the month of Mar-22 has 175 records, out of which meter reading-based volume is available for only 99 connections. Additionally, a 14connection list was received with billed volume of November 2021, out of which meter reading-based volume was available for 13 connections. Total volume in the Billed Metered Category was calculated using these records. The data is enclosed in Annexure 3 and summary of Billed Metered Volume is presented below.

| Details               | Est. Monthly Consumption<br>(ML/month) | Est. Yearly Consumption<br>(ML/Year) |
|-----------------------|--|--------------------------------------|
| Billed Metered Volume | 119.30                                 | 1431.66                              |

TABLE 22 SUMMARY - BILLED METERED CONSUMPTION

**Billed Unmetered:** Meters are not installed for most of the consumers in Solapur and water charges are collected along with Property Taxes. A list of unmetered authorized individual connection consumers as per latest consumer survey is shown in the table below.

TABLE 23 LIST OF AUTHORIZED UNMETERED INDIVIDUAL CONNECTIONS

| S.No. | Conn. Dia. mm | Domestic      | Nondomestic  | Total         |
|-------|---------------|---------------|--------------|---------------|
| 1     | 15            | 114783        | 11605        | <b>126388</b> |
| 2     | 20            | 1080          | 379          | <b>1459</b>   |
|       | <b>Total</b>  | <b>115863</b> | <b>11984</b> | <b>127847</b> |

For average billed consumers, meters were installed and consumption readings were collected for a sample of consumers based on the permission received from utility and consumers. Details of meter sampling is provided in Annexure 3. Average sample volumes:

TABLE 24 SUMMARY - METER SAMPLING FOR INDIVIDUAL CONNECTIONS

| Sample Meter Details | Avg. Monthly Volume (m3) |
|----------------------|--------------------------|
| <b>Domestic</b>      |                          |
| 15mm                 | 10.28                    |
| 20mm                 | 22.29                    |
| <b>Other</b>         |                          |
| 15mm                 | 22.38                    |
| 20mm                 | 23.85                    |

Volume estimates for individual connections:

TABLE 25 VOLUMETRIC ESTIMATES FOR INDIVIDUAL CONNECTIONS



| Category | Size of Conn. (mm) | Count  | Sample Volume per Month (m3) | Est. Yearly Consumption (ML/Year) |
|----------|--------------------|--------|------------------------------|-----------------------------------|
| Domestic | 15                 | 114783 | 10.28                        | 14159.63                          |
|          | 20                 | 1080   | 22.29                        | 288.88                            |
| Other    | 15                 | 11605  | 22.38                        | 3116.64                           |
|          | 20                 | 379    | 23.85                        | 108.47                            |
|          |                    |        | <b>Total</b>                 | <b>17,673.62</b>                  |

Average sample volume was used to calculate consumption of Average Billed Individual Connection Consumers. Apart from individual connections, there are 127354 General Tax Properties that do not have tap connections but receive/use SMC water by other local sources. e.g. PSP. Surveyed properties without tap connection as per latest consumer survey is 29,801. Since there is huge deviation in the figures, General Tax Property figures are considered for Audit calculation.

For unit volume estimates, meters were installed and consumption readings were collected for a sample of Public Stand Post locations. Average sample volume along with supply schedule information was used to calculate average unit consumption. Details of meter sampling are provided in Annexure 3. Average sample volumes:

TABLE 26 PSP SAMPLE VOLUME

| Sample Meter Details | Avg. Consumption Per PSP (m3/month) | Avg. Consumption Per House(m3/month) |
|----------------------|-------------------------------------|--------------------------------------|
| PSP                  | 18.56                               | 3.28                                 |

PSP fed fractional consumers:

TABLE 27 ESTIMATED CONSUMPTION FROM PSP

| Category   | Count   | Sample Volume per Month (m3) | Est. Yearly Consumption (ML/Year) |
|------------|---------|------------------------------|-----------------------------------|
| Properties | 127,354 | 3.28                         | 5,012.65                          |

Estimated yearly billed unmetered volume:

TABLE 28 BILLED UNMETERED VOLUME

| Details                 | Est. Monthly Consumption (ML/month) | Est. Yearly Consumption (ML/Year) |
|-------------------------|-------------------------------------|-----------------------------------|
| Billed Unmetered Volume | 1890.52                             | 22,686.27                         |

**Unbilled Metered:** There is no metered but unbilled category in Solapur.

**Unbilled Unmetered:** Total Slum property surveyed is 38,483. Which is lesser than count received from SMC. Hence SMC data is considered for Audit calculations. Details are mentioned in Annexure 4.

TABLE 29 SLUM POPULATION

| Details                   | Declared | Not Declared | Total   |
|---------------------------|----------|--------------|---------|
| Slum Population           | 220,104  | 46,165       | 266,269 |
| Slum Count                | 48,577   | 11,701       | 60,278  |
| Avg. Population Per House |          |              | 4.42    |

It is not very clear how much of this population should be considered under Unbilled Unmetered and Unauthorized consumption categories. Through site visits sample consumption for PSPs was captured during audit period. A limited number of PSPs were installed by SMC, but many PSPs have been erected by residents making it hard to differentiate. Based on discussion with WAPCOS/SMC it is assumed that there is one PSP for every 140 residents (approx. 30 houses). During the meter sampling, PSPs were seen more frequently, anywhere between every 10-15 houses. Hence a fraction of PSP consumption can be categorized as unauthorized. For the volume estimation, half of the volume is considered unbilled unmetered and half is considered unauthorized. Efforts can be made during the ongoing consumer survey for refining the estimated division of authorized and unauthorized.

TABLE 30 SLUM POPULATION AND UNBILLED VOLUME

| Details | Slum Count | Avg. Consumption per House (m <sup>3</sup> /month) | Est. Total Consumption (ML/Year) | Unbilled Unmetered (ML/Year) |
|---------|------------|--|----------------------------------|------------------------------|
| Slums   | 60,278     | 3.28   | 2,372.54                         | 1,186.27                     |

Public utilities and services account for limited volume and for Solapur this is not a significant category compared to other categories. Various consideration and assumptions, data from WAPCOS/SMC along with field visits were used for quantification of this volume. Details are enclosed in Annexure 3 and 4. Estimated volumes:

TABLE 31 PUBLIC UTILITIES AND OTHER UNBILLED VOLUME

| Details                         | Count | Est. Yearly Volume (ML/Year) |
|---------------------------------|-------|------------------------------|
| Public Toilet                   | 30    | 10.8                         |
| Park/Playground                 | 37    | 13.32                        |
| Swimming Pool                   | 2     | 36                           |
| Fire Brigade                    | 2     | 12                           |
| Medical                         | 49    | 88.2                         |
| Religious                       | 94    | 33.84                        |
| Institutional                   | 49    | 58.8                         |
| Open Market                     | 41    | 29.52                        |
| Public Building                 | 25    | 9                            |
| Construction, Maintenance etc   | 12    | 120                          |
| Est. Tanker Supply Water Volume |       | 51.67                        |
| <b>Estimated Total Volume</b>   |       | <b>463.15</b>                |

Estimated yearly unbilled unmetered volume:

TABLE 32 UNBILLED UNMETERED VOLUME

| Details                   | Est. Monthly Consumption<br>(ML/month) | Est. Yearly Consumption<br>(ML/Year) |
|---------------------------|--|--------------------------------------|
| Unbilled Unmetered Volume | 137.45                                 | 1649.42                              |

## WATER LOSS

**Unauthorized consumption:** Part of slum population is considered in this category. The illegal consumption points are also considered under this category. Based on consumer survey, there are 5600 properties with illegal connection. This value should be revised once the DMA strategy is implemented, and more granular consumer data is available along with regular SCADA data. Estimated volume calculation:

TABLE 33 ILLEGAL CONSUMPTION ESTIMATE

| Size         | Count | Sample Volume per Month (m3) | Est. Yearly Consumption (ML/Year) |
|--------------|-------|------------------------------|-----------------------------------|
| 15mm         | 5349  | 10.28                        | 659.85                            |
| 20mm         | 251   | 22.29                        | 67.14                             |
| <b>Total</b> |       |                              | <b>726.99</b>                     |

Unauthorized Volume for slum population is already discussed in detail in the Unbilled Unauthorized section above. Estimated Unauthorized consumption for the slum population:

TABLE 34 SLUM POPULATION AND UNAUTHORIZED VOLUME

| Details | Slum Count | Avg. Consumption per House (m3/month) | Est. Total Consumption | Unauthorized |
|---------|------------|---------------------------------------|------------------------|--------------|
| Slums   | 60,278     | 3.28                                  | 2,372.54               | 1,186.27     |

Various unaccounted 25mm+ connections were found during consumer survey. Ideally these consumers should be part of Billed Metered Volume but are clearly not billed based on consumption volume as per SMC records. Hence the difference between estimated and indicative unaccounted flow and billed metered volume is considered unauthorized since the connection size is higher than 20mm and these consumers may not be considered billed unmetered based on general property tax collection records. Indicative volume estimates are mentioned in the table below.

TABLE 35 UNACCOUNTED VOLUME

| Monthly Volume (ML) | Size      | Count | Est. Yearly Vol. (ML) | Billed Metered Vol. | Balance Vol. (ML) |
|---------------------|-----------|-------|-----------------------|---------------------|-------------------|
| 895.82              | 25mm<br>+ | 2711  | 10749.84              | 1431.66             | 9318.18           |

Further site inspection by billing department of SMC may be required to clear the status of these consumers, and as the connection size is higher, it should be given higher priority compared to

other consumer metering works. Ideally these consumers should be installed with AMR meters to collect monthly billed volume automatically without manual intervention.

Estimated yearly unauthorized consumption volume:

TABLE 36 UNAUTHORIZED CONSUMPTION

| Details                  | Est. Monthly Consumption (ML/month) | Est. Yearly Consumption (ML/Year) |
|--------------------------|-------------------------------------|-----------------------------------|
| Unauthorized Consumption | 935.96                              | 11231.48                          |

**Customer Meter Inaccuracies and Data Handling Error:** Most of the consumers have 15mm meter size connections, and these consumers have no metered volume hence the impact of meter error is not applicable to more than 99% of consumers. Since the billed metered volume is less than 1% the meter inaccuracies and data handling error will not make much difference in the overall calculation and can be eliminated from the calculation until a significant number of consumers are billed based on meter reading.

**Real Loss:** Since most of the tanks are bypassed, it is clear that most of the ESRs are not filled to the maximum level. Given that the ESRs are bypassed overflows negligible; the same was also verified in discussions with field staff. Most of the real loss is present in the form of transmission and distribution losses plus house service connection leakages/water wastage/misuse at tail end points. Leakage and repair records are not centrally maintained by the Utility. Indicatively, Unavoidable Annual Real Loss estimates range from 30 to 385 ML/Year depending on percentage of time an area is pressurized. The longer the time, higher UARL. Compared to CARL (29,594 ML/Year) it is very low resulting in an ILI value (CARL/UARL) that is very high.

There are no DMAs in place. DMA implementation is just started in part of the city under the Smart City Project. Proper network sectorization along with monthly DMA and Transmission Network water loss monitoring helps in targeted actions for improvements. A software solution is also required to consolidate SCADA, billing and other data, carry out analytics and help Utility in Transmission Network and DMA water loss monitoring.

**4. IWA WATER BALANCE**

IWA Water Balance Table has been prepared using various component assessment as mentioned above.

TABLE 37 IWA WATER BALANCE

|  |  |   |   |  |
|--|--|---|---|--|
| <b>System<br/>Input<br/>Volume<br/>70,385 ML</b> | <b>Authorized<br/>Consumption<br/>29,559ML<br/>43%</b> | <b>Billed<br/>Authorized<br/>27,910 ML<br/>40%</b>  | <b>Billed Water Exported</b><br>3,792 ML<br>5%  | <b>Revenue<br/>Water<br/>27,910 ML<br/>40%</b> |
|  |  |   | <b>Billed Metered</b><br>1,432 ML<br>2%   |  |
|  |  |   | <b>Billed Unmetered</b><br>22,686ML<br>32%  |  |
|  | <b>Unbilled<br/>Authorized<br/>1,649 ML<br/>2%</b>     | <b>Unbilled Metered</b><br>N/A                      | <b>Non-<br/>Revenue<br/>Water<br/>42,475ML<br/>60%</b>  |  |
|  |  | <b>Unbilled Unmetered</b><br>1,649ML<br>2%          |   |  |
|  | <b>Water Losses<br/>40,825 ML<br/>58%</b>              | <b>Apparent<br/>Losses<br/>11,231ML<br/>16%</b>     | <b>Unauthorized</b><br>11,231ML<br>16%  |  |
|  |  |   | <b>Cust. Meter Inaccuracy &amp; Data<br/>Handling Errors<br/>Negligible</b>   |  |
|  |  | <b>Real Losses<br/>(CARL)<br/>29,594 ML<br/>42%</b> | <b>Leakage in Transmission and<br/>Distribution Mains<br/><br/>Storage Leaks and Overflows<br/><br/>Service Con. Leaks up to Meters</b> |  |

It is important to notice that Billed Metered Volume is very minimal. This is due to very limited metering in the city. Since meter installation is underway in ABD area, this situation will improve. This is crucial for better water network management. Non-Revenue water is estimated to be 60%



which is directly related to Billed Metered and Unmetered volume. Detailed analysis of deficiency and improvement suggestions are discussed in subsequent section.

For further tuning and maintenance of the Water Balance it is important to ensure continuous data capture and frequent Water Balance calculation. The Ideal approach is to initiate an Operational Visibility project where necessary sensors are installed and monthly data is captured and analyzed. It is at Utility's discretion to determine the best methods to reduce Water Loss or NRW. Monthly water loss operational visibility is the key step for any future improvement work. Any existing DMA projects can also be included for monthly operational visibility of Water Losses. Overall, this Water Data Audit will help in making informed decisions on all future water supply improvement and loss reduction projects.

## 5. DEFICIENCIES & IMPROVEMENT SUGGESTIONS

### 5.1 LIST OF DEFICIENCIES

- Flowmeters that measure the total system input volume from 3 WTPs and 2 water export locations (MIDC, Godutai Parulekar Taping) are very important for accurate Water Balance calculation. In this current study there were inlet locations without flow meters but there were flow meters that were installed but not working. Among all flow meters, it should be Priority 1 to repair or install Flowmeters at these locations. For the current study, temporary measurements were carried out and correlated with logbook data to assess System Input Volume. Priority 1 locations for flow meter installation/repair/SCADA connection are shown below.

TABLE 5:1: PRIORITY 1 - MEASUREMENT LOCATIONS

| S. No. | Measurement Locations for Clear Water System Input Points |
|--------|---|
| 1      | Bhavani Peth Clear Water Mains (3 No.)                    |
| 2      | Pakhni TM Inlet to Bhavani Peth CWR (1 No.)               |
| 3      | Pakhni Clear Water Main (1 No.)                           |
| 4      | Soregaon Clear Water Main (1 No.)                         |
| 5      | MIDC Chincholi Taping (1 No.)                             |
| 6      | Godutai Parulekar Taping (1 No.)                          |

- Pressure measurement at discharge side of pump provides insight on pump operations. Ideally pressure loggers should be installed, but until SCADA is implemented, pressure gauges can be used and every hour pressure data can be logged. For the current study portable pressure loggers were installed.
- Inlet Flowmeters at Service Reservoirs/Level gauges in Tanks are very important for understanding volume distribution across areas. For Solapur, logging inlet flow data hourly will provide the insights needed for better rationalization of water supply. For the current study, overall flow distribution is assessed by sample meters, surveys and tank data. Status of flowmeters is shown below. Flowmeter installation/repair/SCADA connections at these locations should ideally be done as priority 2 after System Inlet points are addressed.

TABLE 5:2 PRIORITY 2 - MEASUREMENT LOCATIONS

| Facility ID | Name of Facility        | Type | Supply Schedule | Capacity (ML) | Used | Bypass? | Inlet FM? | FM Working? |
|-------------|-------------------------|------|-----------------|---------------|------|---------|-----------|-------------|
| FAC-001     | <b>KEGAON ESR(OLD)</b>  | ESR  | NOT IN USE      | 0.04          | NO   |         | NO        |             |
| FAC-002     | <b>KEGAON ESR</b>       | ESR  | EVERY FOURH DAY | 0.80          | YES  | YES     | NO        |             |
| FAC-003     | <b>BALE ESR OLD</b>     | ESR  | NOT IN USE      | 0.07          | NO   |         | NO        |             |
| FAC-004     | <b>BALE ESR NEW</b>     | ESR  | EVERY FOURH DAY | 2.00          | YES  | YES     | YES       | NO          |
| FAC-005     | <b>AWANTI NAGAR ESR</b> | ESR  | EVERY           | 2.75          | YES  | YES     | YES       | NO          |

|         |                                       |     | FOURH DAY       |       |     |     |     |     |
|---------|---------------------------------------|-----|-----------------|-------|-----|-----|-----|-----|
| FAC-006 | <b>NEW AVANTINAGAR ESR (AMRUT)</b>    | ESR | ALTERNATE DAYS  | 1.20  | YES | NO  | NO  |     |
| FAC-007 | <b>DEGAON ESR OLD</b>                 | ESR | NOT IN USE      | 0.20  | NO  |     | NO  |     |
| FAC-008 | <b>DEGAON ESR NEW</b>                 | ESR | EVERY FOURH DAY | 1.00  | YES | YES | NO  |     |
| FAC-009 | <b>BASAVESHWAR TANK</b>               | ESR | EVERY FOURH DAY | 0.60  | YES | YES | YES | NO  |
| FAC-010 | <b>INDRADHANU ESR (A MR-UT)</b>       | ESR | EVERY FOURH DAY | 1.60  | YES | YES | NO  |     |
| FAC-011 | <b>SALGAR VASTI TANK</b>              | ESR | EVERY FOURH DAY | 0.40  | YES | YES | NO  |     |
| FAC-012 | <b>SETTLEMENT (SALGAR VASTI) ESR</b>  | ESR | DAILY           | 1.50  | YES | YES | NO  |     |
| FAC-013 | <b>ADITYA NAGAR ESR</b>               | ESR | EVERY FOURH DAY | 1.50  | YES | YES | YES | NO  |
| FAC-014 | <b>NEHRU NAGAR ESR</b>                | ESR | DAILY           | 1.80  | YES | NO  | YES | YES |
| FAC-015 | <b>ASHOK NAGAR ESR</b>                | ESR | EVERY FOURH DAY | 0.90  | YES | NO  | NO  |     |
| FAC-016 | <b>PRATAP NAGAR TANK</b>              | ESR | EVERY FOURH DAY | 0.50  | YES | YES | YES | NO  |
| FAC-017 | <b>MBR JULE SOLAPUR 2ML</b>           | MBR | ESR FILLING     | 2.00  | YES | NO  | YES | NO  |
| FAC-018 | <b>MBR JULE SOLAPUR 2.5ML</b>         | MBR | NOT IN USE      | 2.50  | NO  |     | YES | NO  |
| FAC-019 | <b>SOREGAON ESR</b>                   | ESR | EVERY FOURH DAY | 1.00  | YES | YES | NO  |     |
| FAC-020 | <b>DAS ESR</b>                        | ESR | DAILY           | 2.00  | YES | YES | YES | YES |
| FAC-021 | <b>OLD HSR (STONE) JULE SOLAPUR</b>   | HSR | DAILY           | 13.50 | YES | NO  | YES | YES |
| FAC-022 | <b>NEW HSR (RCC) JULE SOLAPUR</b>     | HSR | DAILY           | 13.50 | YES | NO  |     |     |
| FAC-023 | <b>MHADA ESR JULE SOLAPUR</b>         | ESR | DAILY           | 1.65  | YES | YES | YES | YES |
| FAC-024 | <b>LOKMAT ESR (INDUSTRIAL ESTATE)</b> | ESR | EVERY FOURH DAY | 1.50  | YES | YES | NO  |     |
| FAC-025 | <b>SHANTI NAGAR ESR</b>               | ESR | EVERY FOURH DAY | 2.00  | YES | YES | YES | NO  |
| FAC-026 | <b>AKKALKOT MIDC ESR (SONI)</b>       | ESR | EVERY FOURH DAY | 2.00  | YES | YES | NO  |     |
| FAC-027 | <b>AKKALKOT MIDC ESR (MAKANE)</b>     | ESR | EVERY FOURH DAY | 2.00  | YES | YES | NO  |     |
| FAC-028 | <b>AKKALKOT MIDC ESR (SMRUTI)</b>     | ESR | DAILY           | 1.00  | YES | YES | NO  |     |
| FAC-029 | <b>KUMTHA ESR OLD</b>                 | ESR | NOT IN USE      | 0.10  | NO  |     | NO  |     |
| FAC-030 | <b>KUMTHA ESR NEW</b>                 | ESR | EVERY           | 1.00  | YES | YES | YES | NO  |

|         |                                       |     | FOURH DAY               |      |     |     |     |     |
|---------|---------------------------------------|-----|-------------------------|------|-----|-----|-----|-----|
| FAC-031 | <b>DSP ESR (OLD)</b>                  | ESR | DAILY                   | 1.82 | YES | YES | YES | NO  |
| FAC-032 | <b>DSP GSR (NEW)</b>                  | GSR | EVERY<br>FOURH DAY      | 1.68 | YES | YES | NO  |     |
| FAC-033 | <b>DSP ESR (NEW)</b>                  | ESR | EVERY<br>FOURH DAY      | 2.00 | YES | YES | NO  |     |
| FAC-034 | <b>MITRGOTRI ESR<br/>OLD 0.9ML</b>    | ESR | NOT IN USE              | 0.90 | NO  |     | NO  |     |
| FAC-035 | <b>MITRGOTRI ESR<br/>OLD 1.8ML</b>    | ESR | DAILY                   | 1.80 | YES | YES | NO  |     |
| FAC-036 | <b>MITRAGOTRI ESR<br/>UID</b>         | ESR | EVERY<br>FOURH DAY      | 2.00 | YES | YES | NO  |     |
| FAC-037 | <b>PHE STORE TANK</b>                 | ESR | ALTERNATE<br>DAYS       | 2.00 | YES | YES | YES | YES |
| FAC-038 | <b>BHAGWAN NAGAR E<br/>SR</b>         | ESR | EVERY<br>FOURH DAY      | 0.02 | YES | NO  | NO  | NO  |
| FAC-039 | <b>SIDDHESHWAR ESR</b>                | ESR | ALTERNATE<br>DAYS       | 2.75 | YES | YES | NO  |     |
| FAC-040 | <b>HIGH LEVEL GSR<br/>STONE</b>       | GSR | DAILY                   | 6.75 | YES | NO  | NO  |     |
| FAC-041 | <b>HIGH LEVEL GSR<br/>RCC</b>         | GSR | DAILY                   | 6.75 | YES | NO  | NO  |     |
| FAC-042 | <b>SONI ESR</b>                       | ESR | EVERY<br>FOURH DAY      | 2.00 | YES | YES | YES | NO  |
| FAC-043 | <b>ZONE ESR (HIGH<br/>LEVEL AREA)</b> | ESR | EVERY<br>FOURH DAY      | 2.00 | YES | YES | NO  |     |
| FAC-044 | <b>KARNIK NAGAR ESR</b>               | ESR | DAILY                   | 1.00 | YES | NO  | YES | NO  |
| FAC-045 | <b>BHADRAWATI ESR<br/>OLD</b>         | ESR | DAILY                   | 1.35 | YES | YES | YES | YES |
| FAC-046 | <b>BHADRAWATI ESR<br/>NEW</b>         | ESR | EVERY<br>FOURH DAY      | 2.50 | YES | YES | YES | YES |
| FAC-047 | <b>JAWAHAR NAGAR<br/>ESR OLD</b>      | ESR | DAILY                   | 0.75 | YES | NO  | YES | YES |
| FAC-048 | <b>JAWAHAR NAGAR<br/>ESR NEW</b>      | ESR | DAILY                   | 0.75 | YES | NO  |     |     |
| FAC-049 | <b>KASTURBA ESR OLD</b>               | ESR | EVERY<br>FOURH DAY      | 2.75 | YES | YES | NO  |     |
| FAC-050 | <b>KASTURBA ESR NEW</b>               | ESR | ALTERNATE<br>DAYS       | 1.50 | YES | NO  | YES | NO  |
| FAC-051 | <b>DAYANAND ESR OLD</b>               | ESR | EVERY<br>FOURH DAY      | 2.50 | YES | YES | YES | YES |
| FAC-052 | <b>DAYANAND ESR NEW<br/>(AMRUT)</b>   | ESR | NOT<br>COMMISSION<br>ED | 1.60 | NO  |     | NO  |     |
| FAC-053 | <b>PARSIVAL GSR<br/>STONE</b>         | GSR | ALTERNATE<br>DAYS       | 3.37 | YES | NO  | NO  |     |
| FAC-054 | <b>PARSIVAL GSR RCC</b>               | GSR | ALTERNATE               | 3.37 | YES | NO  | NO  |     |

|         |                             |     | DAYS        |     |     |     |     |    |
|---------|-----------------------------|-----|-------------|-----|-----|-----|-----|----|
| FAC-055 | <b>SHELGI ESR OLD</b>       | ESR | NOT IN USE  | 0.1 | NO  |     | NO  |    |
| FAC-056 | <b>SHELGI ESR NEW</b>       | ESR | DAILY       | 1.5 | YES | YES | YES | NO |
| FAC-057 | <b>DAHITANE ESR (UID)</b>   | ESR | NOT IN USE  | 0.6 | NO  |     | NO  |    |
| FAC-058 | <b>VIDI GHARKUL ESR OLD</b> | ESR | DAILY       | 0.4 | YES | YES | NO  |    |
| FAC-059 | <b>VIDI GHARKUL ESR NEW</b> | ESR | DAILY       | 2   | YES | YES | YES | NO |
| FAC-060 | <b>MBR PUNE NAKA MBR 1</b>  | MBR | ESR FILLING | 2.5 | YES | YES | YES | NO |
| FAC-061 | <b>MBR PUNE NAKA MBR 2</b>  | MBR | ESR FILLING | 2.5 | YES | YES | YES | NO |

4. There are many Tapings from the Transmission System. And post rehabilitation, these are planned to be shifted to the ESR command area. But if the rehabilitation is not planned within the next 5 years, these tapings should be monitored with Flow and Pressure Loggers 24x7 as Priority 3. List of taping points:

TABLE 5:3LIST OF KNOWN TAPINGS

| <b>Audit Components</b> | <b>Audit Components</b>  |
|-------------------------|--|
| T1                      | SOLAPUR VIDYAPITH, MAHILA POLICE PRASHIKSHAN KENDRA ETC (MBR OUTLET) (300MM CI)            |
| T2                      | SHIVAJI NAGAR (AT NORTH SIDE OF NH ) (200MM)   |
| T3                      | LAKSHMI NAGAR, RAHUL NAGAR ETC. (200MM)  |
| T4                      | WARAD FARM (KASBE SOLAPUR 1) 350MM   |
| T5                      | SHARAD CHANDRA PAWAR SCHOOL AREA (150MM)   |
| T6                      | MATE MADA AREA, DUMVASTI AREA (150MM)  |
| T7                      | UMA NAGRI  |
| T8                      | MARIAAI CHOWK DISTRIBUTION LINE (300 MM)   |
| T9                      | MARIAAI CHOWK TRANSMISSION LINE FOR DEAGOAN & BASVESHWAR ESR (400 MM)                      |
| T10                     | INDIRA NAGAR CHOWK TAPING OLD DISTRIBUTION OF NEHRUNAGAR ESR FILLING OF 864 MM DIA (300MM) |
| T11                     | INDIRA NAGAR CHOWK FILING FOR ADITYA NAGAR SUMP (600MM)                                    |
| T12                     | TAPING ON RIGHT SIDE OF GATE ITI FOR NEHRU NAGAR NEW SUMP (400MM)                          |
| T13                     | OLD 450MM LINE TAPING ON 1219 AT HSR AREA FROM ASARA CHOWK                                 |
| T14                     | TAPING FOR DSP ESR   |
| T15                     | 450MM BRANCH ON 700 MM DIA FOR MIDC ESR  |
| T16                     | 300MM PATHRUD CHOWK AREA   |



|     |  |
|-----|--|
| T17 | OFFICER CLUB 300 MM LIDING MAIN FOR JAWAR NAGAR ESR                          |
| T18 | TAPING FOR GANDHI NAGAR AREA   |
| T19 | MARKANDE SWIMMING TANK TAPING  |
| T20 | TAPING FOR PHE ESR AND SIDDHESHWAR ESR                                       |
| T21 | LOKOTANDA AND SURROUNDING AREA (150 MM) AND OLD SOREGAON TANK GETTING FILLED |
| T22 | SAIFUL CHOWK (350 MM)  |
| T23 | BEHIND SRPF AREA (150 MM)  |
| T24 | FIRE FIGHTING SERVICE, VISHRANTI NAGAR AREA                                  |
| T25 | MADDI VASTI AREA   |
| T26 | GHONDE VASTI   |
| T27 | OLD SHELAGI AREA GETTING FED NEW SHELAGI ESR LEADING MAIN (250 MM)           |
| T28 | DAHITANE AREA DISTRIBUTION   |

5. Consumer Survey is ongoing so total survey analysis cannot be done. Intermediate analysis is attached as Annexure 4. Key Point Summary:

TABLE 5.4: SUMMARY - CONSUMER SURVEY

| <b>Total Survey Record Count</b> | <b>118,078</b> | <b>Perc.</b> |
|----------------------------------|----------------|--------------|
| Missing geolocation              | 5,388.00       | 5%           |
| Missing Connection Info          | 16,612.00      | 14%          |
| Missing Meter Details            | 1,519.00       | 1%           |
| Illegal Connection               | 2,846.00       | 2%           |

6. Flowmeters should also be installed at each distribution line outlet from service reservoirs. Some of it will coincide with DMA Inlets, the remainder will form Distribution Mains. DMA planning is underway and DMA Inlet/Outlet meters should be installed along with rehabilitation work in the area. The Consumer Survey will provide crucial data (consumer type and count along with geographical location) for DMA formation. Based on that, DMA boundaries can be determined for field implementation. Consumer Survey was 76% complete when this report was prepared and should be completed as soon as possible for efficient DMA planning.
7. Consumer meters should be installed and monthly volumes should be captured per DMA to assess water loss on a monthly basis. The prime objective of metering is to assess the percentage of water consumed vs delivered, which helps in highlighting areas with water loss. In Solapur most of the connections are unmetered. In the current study, meter sampling is used to assess consumption. The domestic consumer metering should ideally coincide with DMA implementation work for the best return on investment.
8. Non-domestic connections should ideally be metered and billed immediately regardless of the DMA implementation schedule. In order to facilitate meter-based billing and monitoring, all

non-domestic meters should ideally be installed with AMR meters with remote reading and billing systems.

9. For assessment of the water supply situation, average and critical points of supply area should be installed with Pressure Loggers. For the current study, a pressure survey was carried out. The pressure logger installation should ideally coincide with DMA implementation work for best return on investment.
10. Leakage and repair data is not centralized, the analysis of past leakages provides insights for future water loss reduction planning. Ideally it should be annexed to the existing complaint and maintenance tracking system.
11. A software solution should be considered for regular water loss calculation and automated monthly reports. This will help in tracking the performance of water supply systems and get early warnings on water loss. If such system is implemented, water loss will be detected early and combined with prompt action to maintain the network and minimize consumer water disruptions. SCADA is under implementation in Solapur. Water loss analysis software usually takes data from SCADA and other data sources and provides water loss calculations on a regular basis. In Solapur, there is no current plans for deployment of Water Network and KPI Monitoring Software and ideally it should be considered for implementation ahead of rehabilitation works.

Solapur Water Network Improvement and Water Loss monitoring and subsequent reduction actions are discussed below.

Currently water losses and wastage at the consumer end cannot be segregated and this will continue to be the case until sectorization and monitoring are implemented. During the preparation of this report, Network rehabilitation, DMA planning and metering (in ABD area) are underway in Solapur which should help in the reduction of NRW. The implementation of SCADA will help in individual sensor data capture. Solapur does not have a Network/DMA visibility system in the current plans. Implementation of this type of system in parallel with the SCADA implementation will increase the usefulness and value of the implementation.

## 5.2 KEY ACTIONS TO BE ADOPTED

The following key action points are suggested for continuous monitoring/improvement of the water supply system and early warning for system failure/faster response planning.

### **Step 1: Capture Field Data**

Suggested Timeline: Immediate

Ensure Flow and Pressure data history is available for:

- (f) All WTP Outlet Pipelines.
- (g) All ESR Inlets before bypass pipeline.

Suggested Timeline: As per planned rehabilitation work

Ensure sensor and meter data is captured in the system after rehabilitation work.

- (h) Install Level Sensors at ESRs that are not bypassed. Subsequently in all ESRs after rehabilitation and closure of bypass.
- (i) Install Flowmeter and Pressure Loggers at DMA Inlet/Outlet points and Pressure Loggers at average and critical points.
- (j) Install consumer meters along with DMA implementation and capture Consumer ID, Coordinates and Meter initial data while installation.

It is suggested to log data every 15 minutes, 24 hours a day, 7 days a week. If the data is not available for various reasons like flowmeter/logger/transmitter not working, repair time should be tracked and targeted to be minimal. 3 days for major repair, 24 hours for minor repair is a good schedule to start with.

## Step 2: Analyze and Monitor

Suggested Timeline: Initiate as soon as possible but after Step 1 (a) and (b) are complete.

Deploy DMA/Network Monitoring software for consolidation of various data including SCADA, Billing, and leakages etc. and for the calculation of system inlet volume estimates along with Water Loss and KPI tracking. Initial observation can be limited to Transmission Network Monitoring and later DMAs can be included as and when established in the field. The software should provide the following outputs:

- (a) Data Analytics: Daily System Inlet Volume and Average Pressure with Graphics and Tabular Export options
- (b) Water Network/KPI Monitoring: Hydraulic Model calibration and correlation with observed data, Monthly Water Supply KPI tracking and Water Loss Estimates, and timely identification of NRW related events.

The purpose of continuous monitoring is to keep a close eye on distribution performance and get relevant data for subsequent improvements.

## Step 3: Yearly Water Loss Reduction Action Plan

(Timeline: Initiate after Step 2.)

Industry best practice is to prepare a yearly Water Loss reduction plan and track the plan throughout the year. If the focus is shifted away from Water Network performance, and smaller issues are not diagnosed and addressed in a timely manner; the cumulative impact will be more demand imbalance, low pressure/no water issues, faster deterioration of the system and associated consumer issues.

Analysis and data from previous steps will provide crucial information for this step. Initially the plan may be focused on Transmission Systems and subsequently include DMAs as they are established. Following are key objectives that should be kept in mind while implanting the plan.

- (a) All sensor data is successfully captured and analyzed for the previous year.
- (b) Review of previous year's action plan and other Capex/Opex work is carried out before planning current year's plan.

- (c) If planned actions are delayed, the reason and associated action to avoid future delay should be included in subsequent year's plan.

The action plan may be created for the calendar or financial year and must be targeted at prime issues with specific actions within the year. The subsequent year action plan should include success/failure/learning inputs from previous year's implementation. This will enable utility in definite success in Water Loss reduction over a period of time.

Strategy for Water Loss Reduction Action Plan will have more relevance once regular Network Monitoring is in place. Key points to cover in action plan are mentioned below.

**1. Review Water Balance and Network Monitoring report and analysis for Loss Reduction Planning and Area Prioritization.**

**2. Apparent Loss Reduction**

- a. Metering of remaining unbilled or unauthorized connections.
- b. Regular reading of existing consumer meters and prompt action on meter related issues.
- c. Law enforcement to handle illegal connection/water theft.
- d. Regular meter testing and replacement plans to keep meter errors to a minimum.

**3. Real Loss Reduction**

- a. Central database and system for all Leakage and Repair work for the city. Inclusion of this data in subsequent network monitoring and analytics.
  - b. Zone and ESR wise tasks to address all visible leakages and water wastage. Inclusion of this data in subsequent network monitoring and analytics.
  - c. Leak Detection Survey as per prioritization derived by network monitoring system. Inclusion of this data in central leakage and repair database.
  - d. Initiate network asset management, pipe condition log along with leakage rate assessment during repair work and water loss calculations per event. Inclusion of this data in subsequent network monitoring and analytics.
  - e. Move towards reward & recognition of staff who is performing best to reduce water loss for encouragement & visibility.
4. Keeping Water loss data Publicly posting Water Loss figures and Water Loss Reduction activities improve accountability and customer confidence.
  5. Assessing utility staff capacity and regular training improve execution efficiency.

## 6. REFERENCES

1. <https://en.wikipedia.org/wiki/Solapur>
2. <http://www.solapurcorporation.gov.in/Default.aspx?AspxAutoDetectCookieSupport=1/>
3. Aquifer maps and ground water management plans, Karmala, Madha, Malshiras, Mohol, Pandharpur South Solapur blocks, Solapur District, Maharashtra
4. <https://solapur.gov.in/en/>
5. <https://en-gb.topographic-map.com/maps/ewwl/Solapur/>
6. <https://censusindia.gov.in/>
7. Augmentation and Improvements in Solapur water supply Scheme” report submitted by “PriMove Infrastructure Development Consultants
8. Draft General Guidelines for Water Audit and Water Conservation by CWC and Central Ground Water Board (April 2017), New Delhi
9. General Guidelines for Water Audit and Water Conservation by CWC Evaluation of Water Utilization Directorate (December 2017), New Delhi



ANNEXURE -1 A (RAW WATER TRANSMISSION SYSTEM KEY MAP)

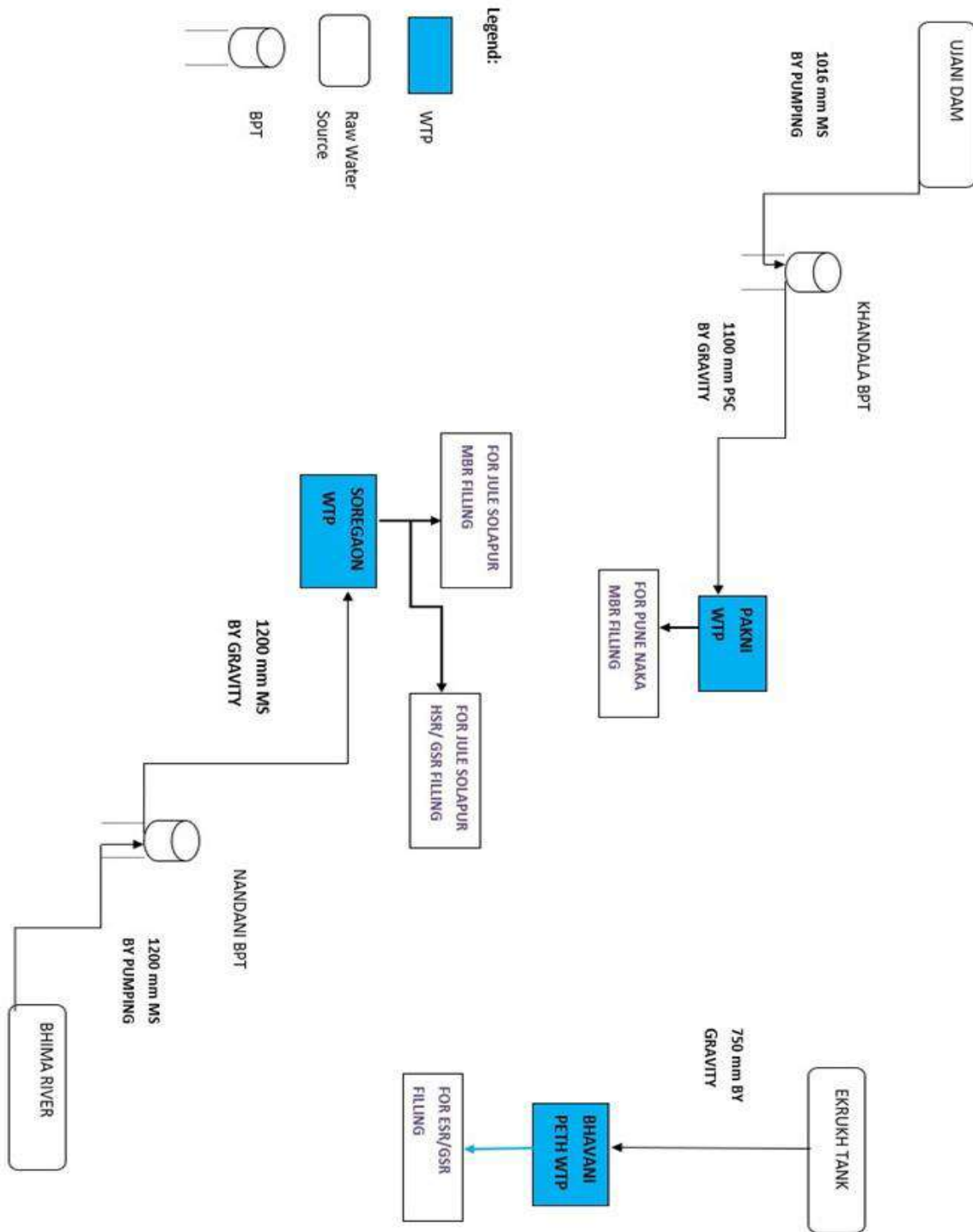

ANNEXURE -1 B (CLEAR WATER TRANSMISSION SYSTEM KEY MAP)

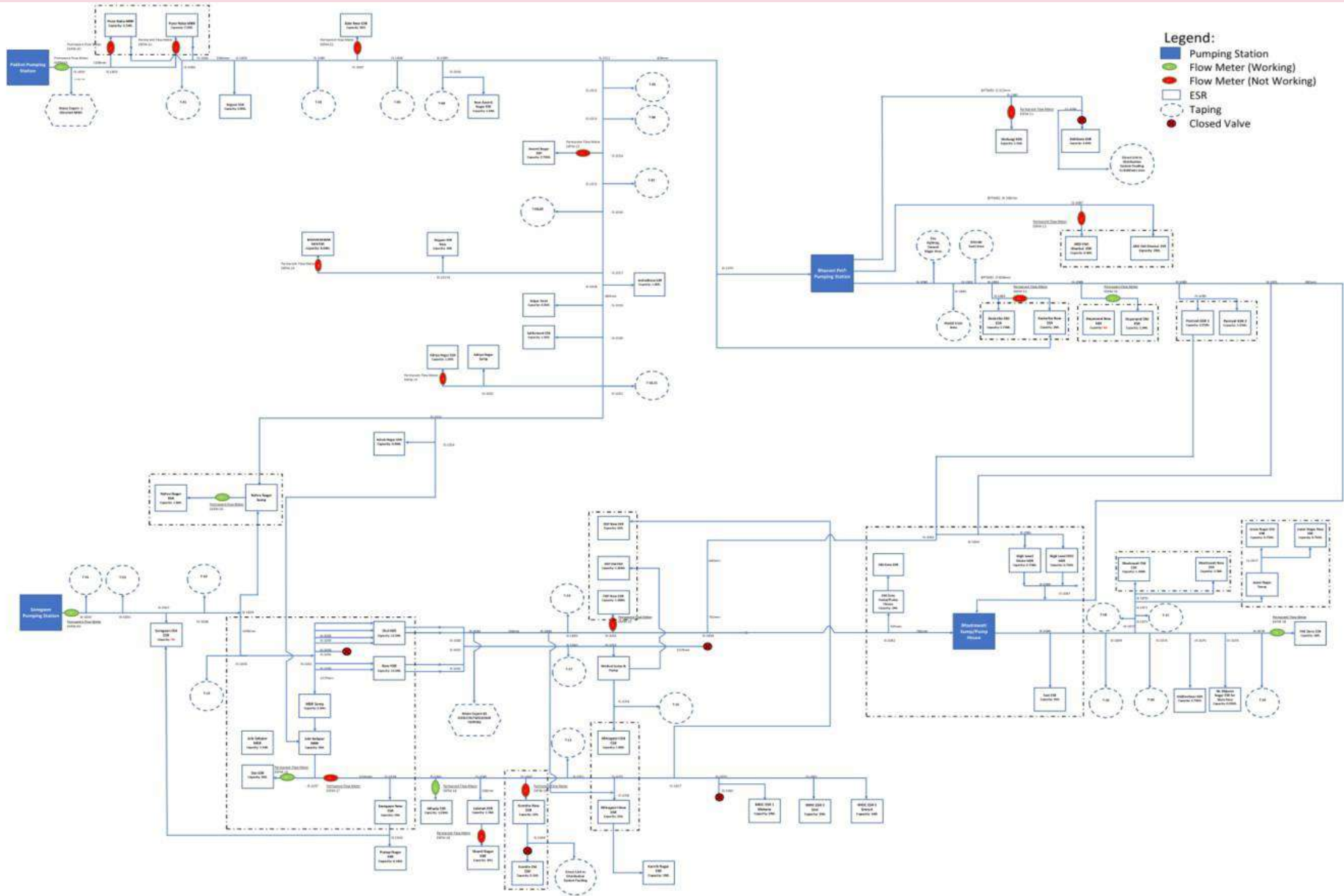

- Legend:**
- Pumping Station
  - Flow Meter (Working)
  - Flow Meter (Not Working)
  - ESR
  - Taping
  - Closed Valve



सोलापूर महानगर पालिका





# सोलापूर महानगरपालिका, सोलापूर

## सार्वजनिक आरोग्य अभियंता

पाणी पुरवठा व पंप हाऊसची माहिती

# सोलापूर शहर पाणी पुरवठा – स्त्रोत



|                 |   |
|-----------------|---|
| लोकसंख्या       | - 9.51 लाख (2011 च्या जनगणने नुसार)<br>11.50 लाख (2022-23 अंदाजे)   |
| क्षेत्रफळ       | - 1989 : 33.03 चौ.किमी.<br>- 1992 : 178.50 चौ.किमी. (हद्दवाढ सह)  |
| पाईप लाईन लांबी | - 1228 किमी (वितरण) + 275 किमी (ट्रान्समिशन) = एकूण 1503 किमी   |
| पाणी साठवण      | - ESR Tank = 51 nos, Design storage = 68.58 ML ,<br>GSR = 06 nos, Design Storage = 23.68 ML<br>HSR = 02 nos, Design Storage = 27.20 ML<br>MBR = 04 nos, Design Storage = 09.50 ML |
| <b>Total =</b>  | <b>63 nos</b> <b>128.96 ML</b>  |





## पाणी पुरवठा उद्भव व वितरण व्यवस्था

| अ क्र | पाणी पुरवठा योजनेचे नाव                       | वर्ष | क्षमता ML     | उपलब्ध पाणी ML |
|-------|---|------|---------------|----------------|
| 1     | एकरूख तलाव (हिप्परगा)                         | 1932 | 27.00         | 20.00          |
| 2     | भीमा नदी टाकळी (औज व चिंचपूर बंधारा)          | 1968 | 108.00        | 100.00         |
| 3     | उजनी जलाशय (उजनी सोलापूर थेट पाईप लाईन) योजना | 1998 | 80.00         | 80.00          |
|       |   |      | <b>215.00</b> | <b>200.00</b>  |

- वितरणा करीता उपलब्ध दैनंदिन पाणी पुरवठा (After Deducting Losses 9%) = 968 दलली
- दैनंदिन इतर बल्क सप्लाय = MIDC चिंचोळी = 90 ML, गोदूताई = 8.50 दलली, लांबोटी MSEB = 3.00 दलली, रेल्वे = 06.00 दलली, City MIDC Ind = 09.00 दलली, इतर = 2.00 दलली असे
- एकूण इतर बल्क सप्लाय = 38.50 दलली
- दैनंदिन प्रत्यक्ष वितरण (968 - 38.50) = 929.50 दलली
- सोलापूर शहरास होणारा पाणी पुरवठ्यावर सेग्रीगेशन स्टोअर येथून नियंत्रण ठेवण्यात येते. सेग्रीगेशन स्टोअर येथे 28 तास तीन्ही शिफ्टमध्ये सेवक काम करीत असतात.

# सोलापूर शहर पाणी पुरवठ्याचे स्रोत



| अक्र | योजनेचे नाव                | कार्यान्वीत वर्ष | पाण्याचे स्रोत | शहरापासून अंतर |
|------|----------------------------|------------------|----------------|----------------|
| १    | हिप्परगा पाणी पुरवठा योजना | १९३८             | हिप्परगा तलाव  | ८ किमी         |
| २    | भीमा पाणीपुरवठा योजना      | १९६८             | भीमा नदी       | ३० किमी        |
| ३    | उजनी धरण पाणीपुरवठा योजना  | १९९६             | उजनी धरण       | १०५ किमी       |

- सोरेगाव जलशुद्धिकरण केंद्र, पाकणी जलशुद्धिकरण केंद्र व भवानीपेठ जलशुद्धिकरण केंद्र येथे कच्चे पाण्यावर शुद्धिकरण प्रक्रियामध्ये तुरटी/पीएसी पावडर व क्लोरीनचा वापर करून सोलापूर शहरास शुद्ध पाणीपुरवठा करण्यात येतो तसेच शहरामध्ये वितरीत होणा-या पाण्याची दररोज तपासणी करण्यात येते.



## सोलापूर शहर पाणी शुद्धिकरण केंद्र

| अ क्र | योजनेचे नाव                | जलशुद्धिकरण केंद्राचे नाव | क्षमता         | सध्याचा प्रत्यक्ष वापर | शहरापासून अंतर |
|-------|----------------------------|---------------------------|----------------|------------------------|----------------|
| १     | हिप्परगा पाणी पुरवठा योजना | भवानी पेठ                 | २७ MLD         | २० MLD                 | शहरामध्ये      |
| २     | भीमा पाणीपुरवठा योजना      | सोरेगाव                   | १०८ MLD        | १०० MLD                | १० किमी        |
| ३     | उजनी धरण पाणीपुरवठा योजना  | पाकणी                     | ८० MLD         | ८० MLD                 | १७ किमी        |
|       |                            | <b>एकूण</b>               | <b>२१५ MLD</b> | <b>२०० MLD</b>         |                |



## सोलापूर शहर स्त्रोत पाईप लाईन

| अक्र | योजनेचे नाव                | पाणी उपसा विवरण   | पंपाची क्षमता  |
|------|----------------------------|---|--|
| १    | हिप्परगा पाणी पुरवठा योजना | हिप्परगा ते भवानी पेठ WTP - ग्रॅव्हिटी  | २५०HP - ०२ nos<br>१२५ HP - ०३ nos<br>९० HP - ०१ nos                                    |
| २    | भीमा पाणीपुरवठा योजना      | <ul style="list-style-type: none"><li>भीमा नदी ते नांदणी BPT - पंपिंग</li><li>नांदणी ते सोरेगाव WTP - ग्रॅव्हिटी</li><li>सोरेगाव WTP ते MBR जुळे सोलापूर - पंपिंग</li></ul>     | <b>टाकळी</b><br>४९५ HP - ०६ nos<br>(४+६)<br><b>सोरेगाव</b><br>४७५ HP - ०५ nos<br>(४+१) |
| ३    | उजनी धरण पाणीपुरवठा योजना  | <ul style="list-style-type: none"><li>उजनी ते खंडाळी BPT - पंपिंग</li><li>खंडाळी BPT ते पाकणी WTP - ग्रॅव्हिटी</li><li>पाकणी WTP ते भवानीपेठ संप व MBR कोंडी - पंपिंग</li></ul> | <b>उजनी</b><br>६९५ HP - ०६ nos<br>(४+२)<br><b>पाकणी</b><br>३५० HP - ०५ nos<br>(३+२)    |

# सोलापूर शहर पाणी पुरवठा

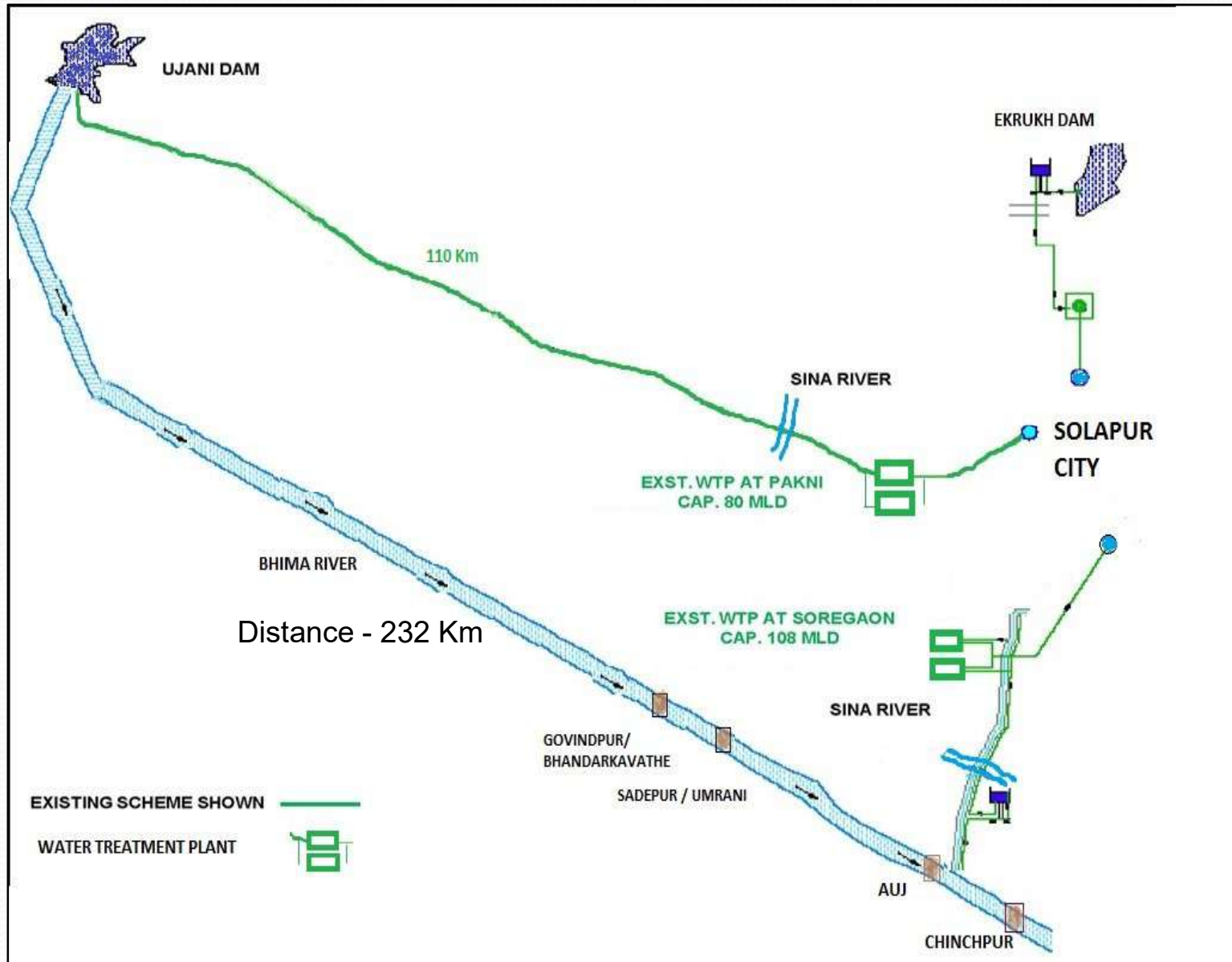







# पाणी पुरवठा – जलवितरण विभाग



| अक्र | विवरण                                | अस्तीत्वातील माहिती |
|------|--------------------------------------|---------------------|
| १    | उंचावरील व जमिनीवरील टाक्याची संख्या | ६३                  |
| २    | उंचावरील व जमिनीवरील टाक्याची क्षमता | १२८.९६ MLD          |
| ३    | एमबीआर टाक्याची संख्या               | ०४ (१० MLD)         |
| ४    | एमबीआर टाक्याची क्षमता               | ०२ (२४ MLD)         |
| ५    | शहरातील डिस्ट्रीब्युशन पाईपलाईन      | १२२८ किमी           |
| ६    | शहरातील ट्रान्समिशन पाईपलाईन         | २७५ किमी            |
|      |                                      |                     |

# पाणी पुरवठा – जलवितरण विभाग



## चार/पाच दिवसाआड पाणीपुरवठा करणेची कारणे

- माहे ऑक्टोंबर २०१९ पासून शहराचे पाच भाग करून प्रत्येक भागास चार/पाच दिवसाआड पाणीपुरवठा करणेत येत आहे.
- शहराचे अवाढव्य (Horizontal Expansion) क्षेत्रफळ व त्या अनुषंगाने कार्यरत अपूरी वितरण व्यवस्था यामुळे शहरास चार/पाच दिवसाआड पाणीपुरवठा करणेत येत आहे.
- हदवाढ भागात अपूरी वितरण व्यवस्था असल्याने टप्याटप्याने सुमारे १५ ते १८ तास सतत पंपीगने पाणीपुरवठा करावा लागत असल्याने ०४/०५ दिवसाआड पाणीपुरवठा केला जात आहे.

# दैनंदिन पाणी पुरवठा करिता योजना



- सोलापूर शहरास दैनंदिन पाणीपुरवठा होण्याकरिता खालील दोन टप्प्यात योजना आखलेली आहे
- टप्पा 1 : सोलापूर शहरासाठी उजनी ते सोलापूर समांतर १७० द.ल.लि. क्षमतेची जलवाहिनी टाकणे
- टप्पा 2 : सोलापूर शहरासाठी वितरण व्यवस्था सुधारणे (अमृत २.० योजने अंतर्गत र.रु.८९२.६३ कोटी इतक्या रक्कमेचा DPR MJP कडे तांत्रिक मंजूरीस्तव सादर करण्यात आलेले आहे. .

# प्रस्तावित वितरण व्यवस्था योजना- MBR & ESR

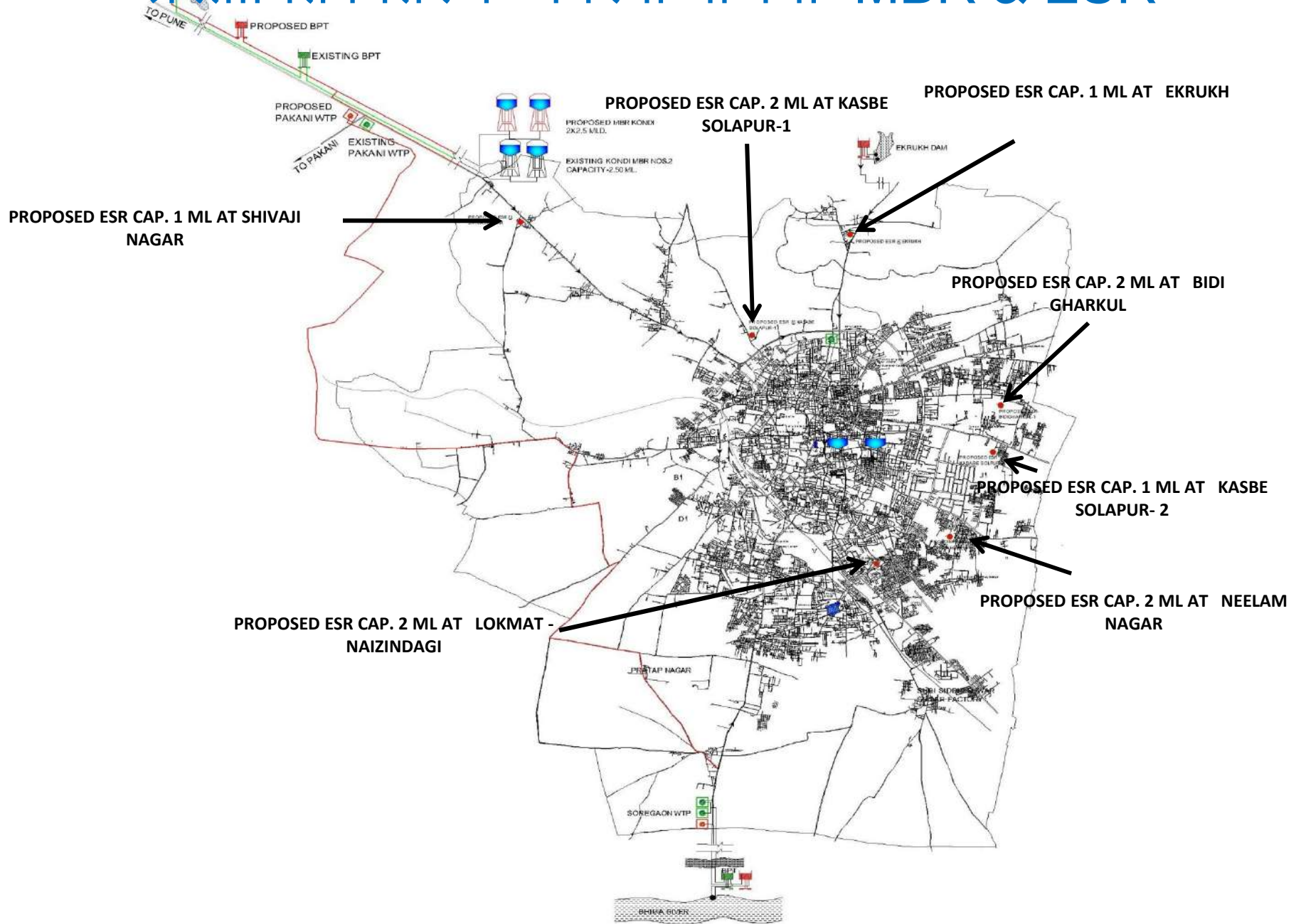



THANK YOU